

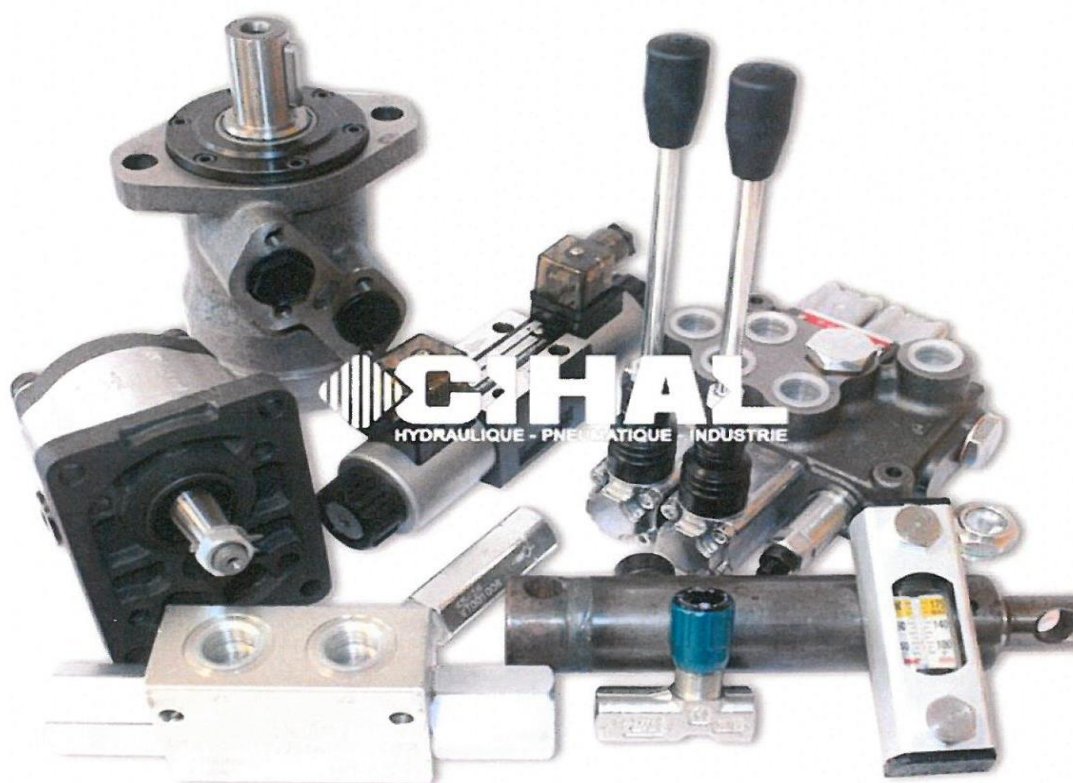

# CIHAL

HYDRAULIQUE - PNEUMATIQUE - INDUSTRIE

## COMPOSANT HYDRAULIQUE



**DISTRIBUTEUR HYDRAULIQUE MANUEL 3/8**

Débit nominal : 35 litres/min  
 Débit maximum : 45 litres/min  
 Pression nominale : 210 bars  
 Pression maximum : 315 bars  
 Raccordements : A , B , P et T en femelle 3/8

TIROIR DE  
 TIROIR SE  
 TIROIR MOTEUR

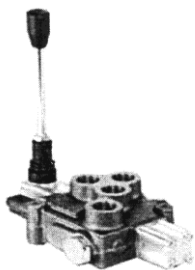
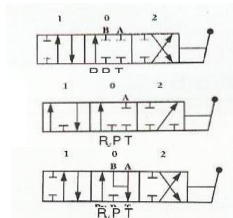

REFERENCE	ELEMENTS	PRESSION	DEBIT	TARIF
DISTRIBUTEUR FM35/1 3/8 D	1	210 bars	35 litres/min	- €
DISTRIBUTEUR FM35/1 3/8 S	1	210 bars	35 litres/min	- €
DISTRIBUTEUR FM35/2 3/8 DD	2	210 bars	35 litres/min	- €
DISTRIBUTEUR FM35/2 3/8 DS	2	210 bars	35 litres/min	- €
DISTRIBUTEUR FM35/3 3/8 DDD	3	210 bars	35 litres/min	- €
DISTRIBUTEUR FM35/3 3/8 DDS	3	210 bars	35 litres/min	- €
DISTRIBUTEUR FM35/4 3/8 DDDD	4	210 bars	35 litres/min	- €
DISTRIBUTEUR FM35/5 3/8 DDDDD	5	210 bars	35 litres/min	- €
DISTRIBUTEUR FM35/6 3/8 DDDDDD	6	210 bars	35 litres/min	- €

TARIFS CI-DESSUS VALABLE POUR DES ELEMENTS DOUBLES EFFET (D) OU SIMPLES EFFET (S)



DIST FM35 TIROIR SIMPLE EFFET	PAR ELEMENT	- €
DIST FM35 TIROIR MOTEUR	PAR ELEMENT	- €
DIST FM35 1 CRANTAGE EN TIRANT	PAR ELEMENT	- €
DIST FM35 1 CRANTAGE EN POUSSANT	PAR ELEMENT	- €
DIST FM35 2 CRANTAGE	PAR ELEMENT	- €
DIST FM35/FM55 CENTRE A SUIVRE		- €
DIST FM35 SUPPORT LEVIER	PAR ELEMENT	- €
DIST FM35 LEVIER	PAR ELEMENT	- €

CRANTAGE EN TIRANT

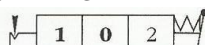

CRANTAGE EN POUSSANT

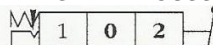

DOUBLE CRANTAGE

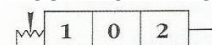

**DISTRIBUTEUR HYDRAULIQUE MANUEL 1/2**

Débit nominal : 55 litres/min  
 Débit maximum : 70 litres/min  
 Pression nominale : 210 bars  
 Pression maximum : 315 bars  
 Raccordements : A , B , P et T en femelle 1/2

TIROIR DE  
 TIROIR SE  
 TIROIR MOTEUR

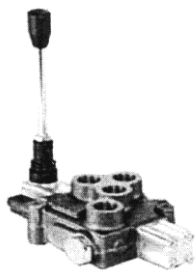
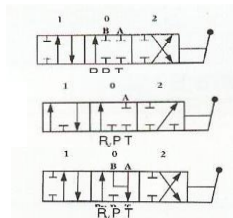

REFERENCE	ELEMENTS	PRESSION	DEBIT	TARIF
DISTRIBUTEUR FM55/1 1/2 D	1	210 bars	55 litres/min	- €
DISTRIBUTEUR FM55/1 1/2 S	1	210 bars	55 litres/min	- €
DISTRIBUTEUR FM55/2 1/2 DD	2	210 bars	55 litres/min	- €
DISTRIBUTEUR FM55/2 1/2 DS	2	210 bars	55 litres/min	- €
DISTRIBUTEUR FM55/3 1/2 DDD	3	210 bars	55 litres/min	- €
DISTRIBUTEUR FM55/3 1/2 DDS	3	210 bars	55 litres/min	- €
DISTRIBUTEUR FM55/4 1/2 DDDD	4	210 bars	55 litres/min	- €
DISTRIBUTEUR FM55/5 1/2 DDDDD	5	210 bars	55 litres/min	- €
DISTRIBUTEUR FM55/6 1/2 DDDDDD	6	210 bars	55 litres/min	- €

TARIFS CI-DESSUS VALABLE POUR DES ELEMENTS DOUBLES EFFET (D) OU SIMPLES EFFET (S)



DIST FM55 TIROIR SIMPLE EFFET	PAR ELEMENT	- €
DIST FM55 TIROIR MOTEUR	PAR ELEMENT	- €
DIST FM55 1 CRANTAGE EN TIRANT	PAR ELEMENT	- €
DIST FM55 1 CRANTAGE EN POUSSANT	PAR ELEMENT	- €
DIST FM55 2 CRANTAGE	PAR ELEMENT	- €
DIST FM35/FM55 CENTRE A SUIVRE		- €
DIST FM55 SUPPORT LEVIER	PAR ELEMENT	- €
DIST FM55 LEVIER	PAR ELEMENT	- €

CRANTAGE EN TIRANT

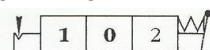

CRANTAGE EN POUSSANT

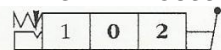

DOUBLE CRANTAGE

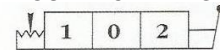

### DISTRIBUTEUR HYDRAULIQUE MANUEL 3/4

Débit nominal : 85-95 litres/min

Débit maximum : 130 litres/min

Pression nominale : 250 bars

Pression maximum : 320 bars

Raccordements : A , B , P et T en femelle 3/4

TIROIR DE

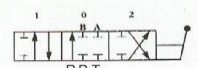

TIROIR SE

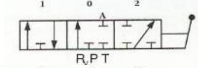

TIROIR MOTEUR

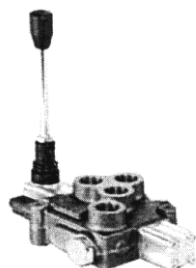
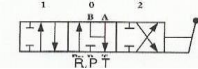

REFERENCE	ELEMENTS	PRESSION	DEBIT	TARIF
DISTRIBUTEUR FM85/1 1/3 D	1	250 bars	95 litres/min	- €
DISTRIBUTEUR FM85/1 3/4 S	1	250 bars	95 litres/min	- €
DISTRIBUTEUR FM85/2 3/4 DD	2	250 bars	95 litres/min	- €
DISTRIBUTEUR FM85/2 3/4 DS	2	250 bars	95 litres/min	- €
DISTRIBUTEUR FM85/3 3/4 DDD	3	250 bars	95 litres/min	- €
DISTRIBUTEUR FM85/3 3/4 DDS	3	250 bars	95 litres/min	- €

TARIFS CI-DESSUS VALABLE POUR DES ELEMENTS DOUBLES EFFET (D) OU SIMPLES EFFET (S)



DIST FM85 TIROIR SIMPLE EFFET	PAR ELEMENT	- €
DIST FM85 TIROIR MOTEUR	PAR ELEMENT	- €
DIST FM85 1 CRANTAGE EN TIRANT	PAR ELEMENT	- €
DIST FM85 1 CRANTAGE EN POUSSANT	PAR ELEMENT	- €
DIST FM85 2 CRANTAGE	PAR ELEMENT	- €
DIST FM85 CENTRE A SUIVRE		- €
DIST FM85 SUPPORT LEVIER	PAR ELEMENT	- €
DIST FM55 LEVIER	PAR ELEMENT	- €

CRANTAGE EN TIRANT

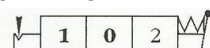

CRANTAGE EN POUSSANT

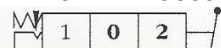

DOUBLE CRANTAGE

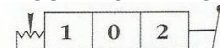

### ADAPTEUR CABLE POUR DISTRIBUTEUR



REFERENCE		DISTRIBUTEUR	TARIF
ADAPTEUR CABLE/DISTRIBUTEUR FM35		FM 35	- €
ADAPTEUR CABLE/DISTRIBUTEUR FM55		FM 55	- €
ADAPTEUR CABLE/DISTRIBUTEUR FM85		FM 85	- €

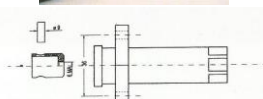

**CABLE DE COMMANDE A DISTANCE**

Rayon de courbure mini : 200mm  
 Effort max sur le cable : 2500N  
 Température de fonctionnement :  
 de -40/+80°C

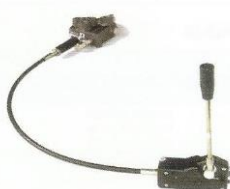
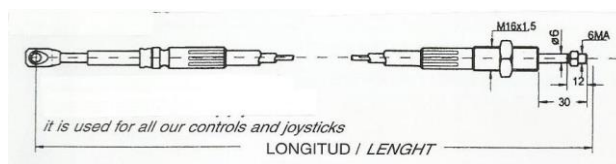

REFERENCE	LONGUEUR			TARIF
CABLE DE COMMANDE L1000MM	1000mm			- €
CABLE DE COMMANDE L1500MM	1500mm			- €
CABLE DE COMMANDE L2000MM	2000mm			- €
CABLE DE COMMANDE L2500MM	2500mm			- €
CABLE DE COMMANDE L3000MM	3000mm			- €
CABLE DE COMMANDE L3500MM	3500mm			- €
CABLE DE COMMANDE L4000MM	4000mm			- €
CABLE DE COMMANDE L4500MM	4500mm			- €
CABLE DE COMMANDE L5000MM	5000mm			- €
CABLE DE COMMANDE L5500MM	5500mm			- €
CABLE DE COMMANDE L6000MM	6000mm			- €

**MONOLEVIER POUR COMMANDE A DISTANCE**



REFERENCE				TARIF
COMMANDE 1 FONCTION DEPORTEE				- €
COMMANDE 1 FONCTION DEPORTEE+ B				- €

**JOYSTICK 2 FONCTIONS POUR COMMANDE A DISTANCE**

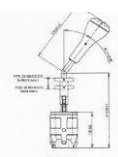

REFERENCE				TARIF
JOYSTICK 2 FONCTIONS				- €
JOYSTICK 2 FONCTIONS + ELEC				- €
JOYSTICK 2 FONCTIONS + BLOCAGE				- €
JOYSTICK ERGONOMIQUE + ELEC + BLOCAGE				- €

**SELECTEUR 6 VOIES - 50 LITRES**



REFERENCE	FILETAGE	PRESSION	DEBIT	TARIF
6RH6 3/8 12VCC	FEM 3/8	210 bars	50 litres/min	- €
6RH6 3/8 24VCC	FEM 3/8	210 bars	50 litres/min	- €
6RH6 3/8 48VCC	FEM 3/8	210 bars	50 litres/min	- €
6RH6 3/8 220VAC	FEM 3/8	210 bars	50 litres/min	- €

**SELECTEUR 8 VOIES - 50 LITRES**



REFERENCE	FILETAGE	PRESSION	DEBIT	TARIF
6RH8 3/8 12VCC	FEM 3/8	210 bars	50 litres/min	- €
6RH8 3/8 24VCC	FEM 3/8	210 bars	50 litres/min	- €
6RH8 3/8 48VCC	FEM 3/8	210 bars	50 litres/min	- €
6RH8 3/8 220VAC	FEM 3/8	210 bars	50 litres/min	- €

**BOBINE DE RECHANGE POUR 6RH6 ET 6RH8**



REFERENCE	FILETAGE	PRESSION	DEBIT	TARIF
BOBINE 6RH6 12VCC				- €
BOBINE 6RH6 24VCC				- €
BOBINE 6RH6 48VCC				- €
BOBINE 6RH6 210VAC				- €

**POIGNEE COBRA**



REFERENCE	FILETAGE	NB CONTACT	DEBIT	TARIF
POIGNEE COBRA PC1		1		- €
POIGNEE COBRA PC2		2		- €
POIGNEE COBRA PC3		3		- €
POIGNEE COBRA PC4		4		- €

**SELECTEUR 6 VOIES - 80 LITRES**



REFERENCE	FILETAGE	PRESSION	DEBIT	TARIF
6RH10 1/2 12VCC	FEM 1/2	250 bars	80 litres/min	- €
6RH10 1/2 24VCC	FEM 1/2	250 bars	80 litres/min	- €
6RH10 1/2 48VCC	FEM 1/2	250 bars	80 litres/min	- €
6RH10 1/2 220VAC	FEM 1/2	250 bars	80 litres/min	- €

**BOBINE DE RECHANGE POUR 6RH10**



REFERENCE	FILETAGE	PRESSION	DEBIT	TARIF
BOBINE 6RH10 12VCC				- €
BOBINE 6RH10 24VCC				- €
BOBINE 6RH10 48VCC				- €
BOBINE 6RH10 210VAC				- €



**ELECTRODISTRIBUTEUR CETOP 3 - 2 BOBINES**

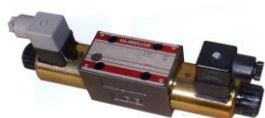

REFERENCE	SCHEMA	PRESSION	DEBIT	TARIF
ELECTRO CETOP3 A1 12VCC		350 bars	50 litres/min	- €
ELECTRO CETOP3 A1 24VCC		350 bars	50 litres/min	- €
ELECTRO CETOP3 A1 110VAC		350 bars	50 litres/min	- €
ELECTRO CETOP3 A1 220VAC		350 bars	50 litres/min	- €



REFERENCE	SCHEMA	PRESSION	DEBIT	TARIF
ELECTRO CETOP3 A2 12VCC		350 bars	50 litres/min	- €
ELECTRO CETOP3 A2 24VCC		350 bars	50 litres/min	- €
ELECTRO CETOP3 A2 110VACC		350 bars	50 litres/min	- €
ELECTRO CETOP3 A2 220VAC		350 bars	50 litres/min	- €



REFERENCE	SCHEMA	PRESSION	DEBIT	TARIF
ELECTRO CETOP3 A3 12VCC		350 bars	50 litres/min	- €
ELECTRO CETOP3 A3 24VCC		350 bars	50 litres/min	- €
ELECTRO CETOP3 A3 110VAC		350 bars	50 litres/min	- €
ELECTRO CETOP3 A3 220VAC		350 bars	50 litres/min	- €



REFERENCE	SCHEMA	PRESSION	DEBIT	TARIF
ELECTRO CETOP3 A4 12VCC		350 bars	50 litres/min	- €
ELECTRO CETOP3 A4 24VCC		350 bars	50 litres/min	- €
ELECTRO CETOP3 A4 110VAC		350 bars	50 litres/min	- €
ELECTRO CETOP3 A4 220VAC		350 bars	50 litres/min	- €

**ELECTRODISTRIBUTEUR CETOP 3 - 1 BOBINES**



REFERENCE	SCHEMA	PRESSION	DEBIT	TARIF
ELECTRO CETOP3 B1 12VCC		350 bars	50 litres/min	- €
ELECTRO CETOP3 B1 24VCC		350 bars	50 litres/min	- €
ELECTRO CETOP3 B1 110VAC		350 bars	50 litres/min	- €
ELECTRO CETOP3 B1 220VAC		350 bars	50 litres/min	- €



REFERENCE	SCHEMA	PRESSION	DEBIT	TARIF
ELECTRO CETOP3 B3 12VCC		350 bars	50 litres/min	- €
ELECTRO CETOP3 B3 24VCC		350 bars	50 litres/min	- €
ELECTRO CETOP3 B3 110VAC		350 bars	50 litres/min	- €
ELECTRO CETOP3 B3 220VAC		350 bars	50 litres/min	- €

**BOBINE DE RECHANGE POUR ELECTRO CETOP 3**



REFERENCE	TENSION	TARIF
BOBINE CETOP3 12VCC	12VCC	- €
BOBINE CETOP3 24VCC	24VCC	- €
BOBINE CETOP3 110VAC	110VACC	- €
BOBINE CETOP3 210VAC	220VAC	- €

**EMBASE SANS LIMITEUR POUR 1 ELECTRO CETOP 3**



REFERENCE	FILETAGE	PRESSION	DEBIT	TARIF
CETOP3 EMBASE 3/8 SANS LIMITEUR	FEM 3/8	350 bars	50 litres/min	- €

**EMBASE AVEC LIMITEUR POUR 1 ELECTRO CETOP 3**

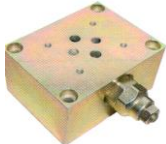

REFERENCE	FILETAGE	PRESSION	DEBIT	TARIF
CETOP3 EMBASE 3/8 AVEC LIMITEUR	FEM 3/8	350 bars	50 litres/min	- €

**BLOC SANS LIMITEUR POUR ELECTRO CETOP 3 (EN PARALLELE)**



REFERENCE	FILETAGE	TENSION		TARIF
CETOP3 BLOC 3/8 2ELTS SANS LIMITEUR	FEM 3/8	350 bars	50 litres/min	- €
CETOP3 BLOC 3/8 3ELTS SANS LIMITEUR	FEM 3/8	350 bars	50 litres/min	- €
CETOP3 BLOC 3/8 4ELTS SANS LIMITEUR	FEM 3/8	350 bars	50 litres/min	- €
CETOP3 BLOC 3/8 5ELTS SANS LIMITEUR	FEM 3/8	350 bars	50 litres/min	- €
CETOP3 BLOC 3/8 6ELTS SANS LIMITEUR	FEM 3/8	350 bars	50 litres/min	- €
CETOP3 BLOC 3/8 7ELTS SANS LIMITEUR	FEM 3/8	350 bars	50 litres/min	- €
CETOP3 BLOC 3/8 8ELTS SANS LIMITEUR	FEM 3/8	350 bars	50 litres/min	- €

**BLOC AVEC LIMITEUR POUR ELECTRO CETOP 3 (EN PARALLELE)**



REFERENCE	FILETAGE	TENSION		TARIF
CETOP3 BLOC 3/8 2ELTS AVEC LIMITEUR	FEM 3/8	350 bars	50 litres/min	- €
CETOP3 BLOC 3/8 3ELTS AVEC LIMITEUR	FEM 3/8	350 bars	50 litres/min	- €
CETOP3 BLOC 3/8 4ELTS AVEC LIMITEUR	FEM 3/8	350 bars	50 litres/min	- €
CETOP3 BLOC 3/8 5ELTS AVEC LIMITEUR	FEM 3/8	350 bars	50 litres/min	- €
CETOP3 BLOC 3/8 6ELTS AVEC LIMITEUR	FEM 3/8	350 bars	50 litres/min	- €
CETOP3 BLOC 3/8 7ELTS AVEC LIMITEUR	FEM 3/8	350 bars	50 litres/min	- €
CETOP3 BLOC 3/8 8ELTS AVEC LIMITEUR	FEM 3/8	350 bars	50 litres/min	- €

**PLAQUE D'OBTURATION CETOP 3**



REFERENCE		PRESSION	DEBIT	TARIF
CETOP3 PLAQUE D'OBTURATION		350 bars	50 litres/min	- €



**PLAQUE DE CONVERSION DE CETOP 3 EN CETOP 5**



REFERENCE		PRESSION	DEBIT	TARIF
PLAQUE DE CONVERSION CETOP3/CETOP5		350 bars	50 litres/min	- €

**CLAPET ANTI-RETOUR POUR CETOP 3**

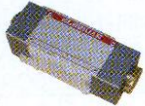

REFERENCE		PRESSION	DEBIT	TARIF
CETOP3 ANTI-RETOUR EN A		350 bars	50 litres/min	SD
CETOP3 ANTI-RETOUR EN A ET B		350 bars	50 litres/min	- €

**ETRANGLEUR DE DEBIT POUR CETOP 3**



REFERENCE		PRESSION	DEBIT	TARIF
CETOP3 ETRANGLEUR EN A ET B		350 bars	50 litres/min	- €

**LIMITEUR DE PRESSION POUR CETOP 3**

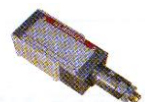

REFERENCE		PRESSION	DEBIT	TARIF
CETOP3 LIMITEUR PRESSION EN A		350 bars	50 litres/min	- €
CETOP3 LIMITEUR PRESSION EN A ET B		350 bars	50 litres/min	- €

**ELECTRODISTRIBUTEUR CETOP 5 - 2 BOBINES**



REFERENCE	SCHEMA	PRESSION	DEBIT	TARIF
ELECTRO CETOP5 A1 12VCC		320 bars	80 litres/min	- €
ELECTRO CETOP5 A1 24VCC		320 bars	80 litres/min	- €
ELECTRO CETOP5 A1 110VAC		320 bars	80 litres/min	- €
ELECTRO CETOP5 A1 220VAC		320 bars	80 litres/min	- €



REFERENCE	SCHEMA	PRESSION	DEBIT	TARIF
ELECTRO CETOP5 A2 12VCC		320 bars	80 litres/min	- €
ELECTRO CETOP5 A2 24VCC		320 bars	80 litres/min	- €
ELECTRO CETOP5 A2 110VAC		320 bars	80 litres/min	- €
ELECTRO CETOP5 A2 220VAC		320 bars	80 litres/min	- €



REFERENCE	SCHEMA	PRESSION	DEBIT	TARIF
ELECTRO CETOP5 A3 12VCC		320 bars	80 litres/min	- €
ELECTRO CETOP5 A3 24VCC		320 bars	80 litres/min	- €
ELECTRO CETOP5 A3 110VAC		320 bars	80 litres/min	- €
ELECTRO CETOP5 A3 220VAC		320 bars	80 litres/min	- €



REFERENCE	SCHEMA	PRESSION	DEBIT	TARIF
ELECTRO CETOP5 A4 12VCC		320 bars	80 litres/min	- €
ELECTRO CETOP5 A4 24VCC		320 bars	80 litres/min	- €
ELECTRO CETOP5 A4 110VAC		320 bars	80 litres/min	- €
ELECTRO CETOP5 A4 220VAC		320 bars	80 litres/min	- €

**ELECTRODISTRIBUTEUR CETOP 5 - 1 BOBINES**



REFERENCE	SCHEMA	PRESSION	DEBIT	TARIF
ELECTRO CETOP5 B1 12VCC		320 bars	80 litres/min	- €
ELECTRO CETOP5 B1 24VCC		320 bars	80 litres/min	- €
ELECTRO CETOP5 B1 110VAC		320 bars	80 litres/min	- €
ELECTRO CETOP5 B1 220VAC		320 bars	80 litres/min	- €



REFERENCE	SCHEMA	PRESSION	DEBIT	TARIF
ELECTRO CETOP5 B3 12VCC		320 bars	80 litres/min	- €
ELECTRO CETOP5 B3 24VCC		320 bars	80 litres/min	- €
ELECTRO CETOP5 B3 110VAC		320 bars	80 litres/min	- €
ELECTRO CETOP5 B3 220VAC		320 bars	80 litres/min	- €

**BOBINE DE RECHANGE POUR ELECTRO CETOP 5**



REFERENCE	TENSION	TARIF
BOBINE CETOP5 12VCC	12VCC	- €
BOBINE CETOP5 24VCC	24VCC	- €
BOBINE CETOP5 48VCC	48VCC	- €
BOBINE CETOP5 210VAC	220VAC	- €

**EMBASE SANS LIMITEUR POUR 1 ELECTRO CETOP 5**



REFERENCE	FILETAGE	PRESSION	DEBIT	TARIF
CETOP5 EMBASE 1/2 SANS LIMITEUR	FEM 1/2	320 bars	80 litres/min	- €

**EMBASE AVEC LIMITEUR POUR 1 ELECTRO CETOP 5**

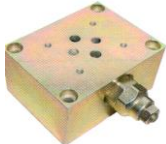

REFERENCE	FILETAGE	PRESSION	DEBIT	TARIF
CETOP5 EMBASE 1/2 AVEC LIMITEUR	FEM 1/2	320 bars	80 litres/min	- €

**BLOC SANS LIMITEUR POUR ELECTRO CETOP 5 (EN PARALLELE)**



REFERENCE	FILETAGE	TENSION		TARIF
CETOP5 BLOC 1/2 2ELTS SANS LIMITEUR	FEM 1/2	320 bars	80 litres/min	- €
CETOP5 BLOC 1/2 3ELTS SANS LIMITEUR	FEM 1/2	320 bars	80 litres/min	- €
CETOP5 BLOC 1/2 4ELTS SANS LIMITEUR	FEM 1/2	320 bars	80 litres/min	- €
CETOP5 BLOC 1/2 5ELTS SANS LIMITEUR	FEM 1/2	320 bars	80 litres/min	- €

**BLOC AVEC LIMITEUR POUR ELECTRO CETOP 5 (EN PARALLELE)**



REFERENCE	FILETAGE	TENSION		TARIF
CETOP5 BLOC 1/2 2ELTS AVEC LIMITEUR	FEM 1/2	320 bars	80 litres/min	- €
CETOP5 BLOC 1/2 3ELTS AVEC LIMITEUR	FEM 1/2	320 bars	80 litres/min	- €
CETOP5 BLOC 1/2 4ELTS AVEC LIMITEUR	FEM 1/2	320 bars	80 litres/min	- €
CETOP5 BLOC 1/2 5ELTS AVEC LIMITEUR	FEM 1/2	320 bars	80 litres/min	- €

**PLAQUE D'OBTURATION CETOP 5**



REFERENCE		PRESSION	DEBIT	TARIF
CETOP5 PLAQUE D'OBTURATION		320 bars	80 litres/min	- €

**PLAQUE DE CONVERSION DE CETOP 3 EN CETOP 5**



REFERENCE		PRESSION	DEBIT	TARIF
PLAQUE DE CONVERSION CETOP3/CETOP5		350 bars	50 litres/min	- €

**CLAPET ANTI-RETOUR POUR CETOP 5**

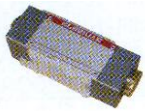

REFERENCE		PRESSION	DEBIT	TARIF
CETOP5 ANTI-RETOUR EN A		320 bars	80 litres/min	SD
CETOP5 ANTI-RETOUR EN B		320 bars	80 litres/min	SD
CETOP5 ANTI-RETOUR EN A ET B		320 bars	80 litres/min	- €

**ETRANGLEUR DE DEBIT POUR CETOP 5**

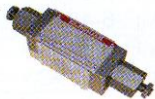

REFERENCE		PRESSION	DEBIT	TARIF
CETOP5 ETRANGLEUR EN A ET B		320 bars	80 litres/min	- €

**LIMITEUR DE PRESSION POUR CETOP 5**

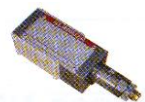

REFERENCE		PRESSION	DEBIT	TARIF
CETOP5 LIMITEUR PRESSION EN A		320 bars	80 litres/min	SD
CETOP5 LIMITEUR PRESSION EN B		320 bars	80 litres/min	SD
CETOP5 LIMITEUR PRESSION EN P		320 bars	80 litres/min	- €

**ELECTROVANNE A CLAPET 2 VOIES - NORMALEMENT OUVERT / NORMALEMENT FERME**

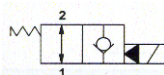

**NORMALEMENT OUVERT**

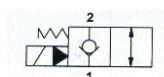

**NORMALEMENT FERME**

REFERENCE	FILETAGE	SCHEMA	DEBIT	PRESSION	TARIF
ELECTRO A CLAPET NO 1/4 12VCC	1/4G		35 l/min	250 bars	<b>SD</b>
ELECTRO A CLAPET NO 1/4 24VCC	1/4G		35 l/min	250 bars	<b>SD</b>
ELECTRO A CLAPET NO 1/4 220VAC	1/4G		35 l/min	250 bars	<b>SD</b>
ELECTRO A CLAPET NO 3/8 12VCC	3/8G		35 l/min	250 bars	- €
ELECTRO A CLAPET NO 3/8 24VCC	3/8G		35 l/min	250 bars	- €
ELECTRO A CLAPET NO 3/8 220VAC	3/8G		35 l/min	250 bars	- €
ELECTRO A CLAPET NO 1/2 12VCC	1/2G		80 l/min	250 bars	- €
ELECTRO A CLAPET NO 1/2 24VCC	1/2G		80 l/min	250 bars	- €
ELECTRO A CLAPET NO 1/2 220VAC	1/2G		80 l/min	250 bars	- €
ELECTRO A CLAPET NO 3/4 12VCC	3/4G		115l/min	210 bars	- €
ELECTRO A CLAPET NO 3/4 24VCC	3/4G		115l/min	210 bars	- €
ELECTRO A CLAPET NO 3/4 220VAC	3/4G		115l/min	210 bars	- €
ELECTRO A CLAPET NF 1/4 12VCC	1/4G		35 l/min	250 bars	<b>SD</b>
ELECTRO A CLAPET NF 1/4 24VCC	1/4G		35 l/min	250 bars	<b>SD</b>
ELECTRO A CLAPET NF 1/4 220VAC	1/4G		35 l/min	250 bars	<b>SD</b>
ELECTRO A CLAPET NF 3/8 12VCC	3/8G		35 l/min	250 bars	- €
ELECTRO A CLAPET NF 3/8 24VCC	3/8G		35 l/min	250 bars	- €
ELECTRO A CLAPET NF 3/8 220VAC	3/8G		35 l/min	250 bars	- €
ELECTRO A CLAPET NF 1/2 12VCC	1/2G		80 l/min	250 bars	- €
ELECTRO A CLAPET NF 1/2 24VCC	1/2G		80 l/min	250 bars	- €
ELECTRO A CLAPET NF 1/2 220VAC	1/2G		80 l/min	250 bars	- €
ELECTRO A CLAPET NF 3/4 12VCC	3/4G		115l/min	210 bars	- €
ELECTRO A CLAPET NF 3/4 24VCC	3/4G		115l/min	210 bars	- €
ELECTRO A CLAPET NF 3/4 220VAC	3/4G		115l/min	210 bars	- €

**ELECTROVANNE A CLAPET 3 VOIES - 3 VOIES AVEC CLAPET AR**



REFERENCE	FILETAGE	SCHEMA	DEBIT	PRESSION	TARIF
ELECTRO A CLAPET 3V 3/8 12VCC	3/8G		20 l/min	220 bars	<b>SD</b>
ELECTRO A CLAPET 3V 3/8 24VCC	3/8G		20 l/min	220 bars	<b>SD</b>
ELECTRO A CLAPET 3V 3/8 220VAC	3/8G		20 l/min	220 bars	<b>SD</b>
ELECTRO A CLAPET 3V 1/2 12VCC	1/2G		30 l/min	220 bars	<b>SD</b>
ELECTRO A CLAPET 3V 1/2 24VCC	1/2G		30 l/min	220 bars	<b>SD</b>
ELECTRO A CLAPET 3V 1/2 220VAC	1/2G		30 l/min	220 bars	<b>SD</b>
ELECTRO A CLAPET 3V 3/4 12VCC	3/4G		60 l/min	220 bars	<b>SD</b>
ELECTRO A CLAPET 3V 3/4 24VCC	3/4G		60 l/min	220 bars	<b>SD</b>
ELECTRO A CLAPET 3V 3/4 220VAC	3/4G		60 l/min	220 bars	<b>SD</b>
ELECTRO A CLAPET 3V-AR 3/8 12VCC	3/8G		25 l/min	220 bars	<b>SD</b>
ELECTRO A CLAPET 3V-AR 3/8 24VCC	3/8G		25 l/min	220 bars	<b>SD</b>
ELECTRO A CLAPET 3V-AR 3/8 220VAC	3/8G		25 l/min	220 bars	<b>SD</b>

**ELECTROVANNE A CLAPET 4 VOIES**



REFERENCE	FILETAGE	SCHEMA	DEBIT	PRESSION	TARIF
ELECTRO A CLAPET 4V-Y 1/2 12VCC	1/2G		20 l/min	220 bars	<b>SD</b>
ELECTRO A CLAPET 4V-Y 1/2 24VCC	1/2G		20 l/min	220 bars	<b>SD</b>
ELECTRO A CLAPET 4V-Y 1/2 220VAC	1/2G		20 l/min	220 bars	<b>SD</b>
ELECTRO A CLAPET 4V-PT 1/2 12VCC	1/2G		20 l/min	220 bars	<b>SD</b>
ELECTRO A CLAPET 4V-PT 1/2 24VCC	1/2G		20 l/min	220 bars	<b>SD</b>
ELECTRO A CLAPET 4V-PT 1/2 220VAC	1/2G		20 l/min	220 bars	<b>SD</b>
ELECTRO A CLAPET 4V-H 1/2 12VCC	1/2G		20 l/min	220 bars	<b>SD</b>
ELECTRO A CLAPET 4V-H 1/2 24VCC	1/2G		20 l/min	220 bars	<b>SD</b>
ELECTRO A CLAPET 4V-H 1/2 220VAC	1/2G		20 l/min	220 bars	<b>SD</b>

**BLOC ALU POUR ELECTROVANNE A CLAPET - SUR DEMANDE**

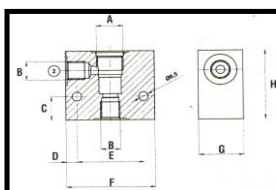

**2 VOIES (NF/NO)**

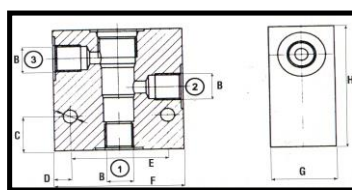

**3 VOIES**

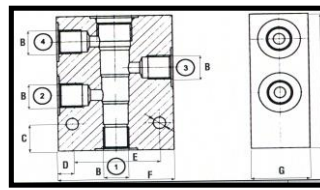

**4 VOIES**

**CARTOUCHE POUR ELECTROVANNE A CLAPET - SUR DEMANDE**

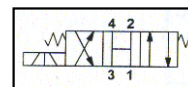
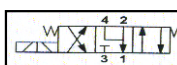
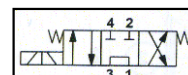
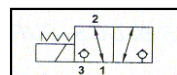
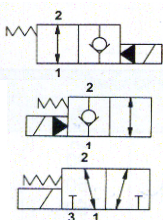

**BOBINE ELECTRIQUE POUR ELECTROVANNE A CLAPET**

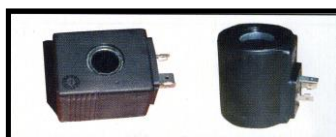

REFERENCE	TAILLE	TENSION	TARIF
BOBINE ELECTRO NF/NO 3/8 12VCC	POUR 3/8	12VCC	- €
BOBINE ELECTRO NF/NO 3/8 24VCC	POUR 3/8	24VCC	- €
BOBINE ELECTRO NF/NO 3/8 110VAC	POUR 3/8	110VAC	- €
BOBINE ELECTRO NF/NO 3/8 220VAC	POUR 3/8	220VAC	- €
BOBINE ELECTRO NF/NO 1/2 12VCC	POUR 1/2	12VCC	- €
BOBINE ELECTRO NF/NO 1/2 24VCC	POUR 1/2	24VCC	- €
BOBINE ELECTRO NF/NO 1/2 110VAC	POUR 1/2	110VAC	- €
BOBINE ELECTRO NF/NO 1/2 220VAC	POUR 1/2	220VAC	- €
BOBINE ELECTRO NF/NO 3/4 12VCC	POUR 3/4	12VCC	- €
BOBINE ELECTRO NF/NO 3/4 24VCC	POUR 3/4	24VCC	- €
BOBINE ELECTRO NF/NO 3/4 110VAC	POUR 3/4	110VAC	- €
BOBINE ELECTRO NF/NO 3/4 220VAC	POUR 3/4	220VAC	- €

CIHAL - Techopole de Forbach Sud

113 RUE ROBERT BUNSEN- 57460 BEHREN LES FORBACH

TEL 03 87 81 51 33 - FAX 03 87 81 22 38 - E-mail: magasin@cihal.fr



**REGULATEUR DE DEBIT UNIDIRECTIONNEL**

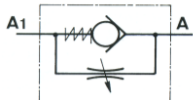

REFERENCE	FILETAGE	PRESSION	DEBIT	TARIF
FT CAR 1/4	FEM 1/4	350 bars	12 litres/min	- €
FT CAR 3/8	FEM 3/8	350 bars	30 litres/min	- €
FT CAR 1/2	FEM 1/2	350 bars	45 litres/min	- €
FT CAR 3/4	FEM 3/4	350 bars	85 litres/min	- €
FT CAR 1"	FEM 1"	320 bars	125 litres/min	- €

**REGULATEUR DE DEBIT BIDIRECTIONNEL**



REFERENCE	FILETAGE	PRESSION	DEBIT	TARIF
FT 1/4	FEM 1/4	350 bars	12 litres/min	- €
FT 3/8	FEM 3/8	350 bars	30 litres/min	- €
FT 1/2	FEM 1/2	350 bars	45 litres/min	- €
FT 3/4	FEM 3/4	350 bars	85 litres/min	- €
FT 1"	FEM 1"	320 bars	125 litres/min	- €

**ETRANGLEUR REGLABLE UNIDIRECTIONNEL**

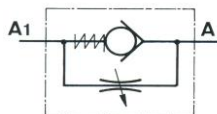

REFERENCE	FILETAGE	PRESSION	DEBIT	TARIF
ER CAR 1/4	FEM 1/4	350 bars	12 litres/min	- €
ER CAR 3/8	FEM 3/8	350 bars	30 litres/min	- €
ER CAR 1/2	FEM 1/2	310 bars	45 litres/min	- €
ER CAR 3/4	FEM 3/4	280 bars	85 litres/min	- €
ER CAR 1"	FEM 1"	250 bars	150 litres/min	- €

**ETRANGLEUR REGLABLE BIDIRECTIONNEL**

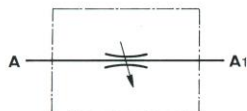

REFERENCE	FILETAGE	PRESSION	DEBIT	TARIF
ER 1/4	FEM 1/4	350 bars	12 litres/min	- €
ER 3/8	FEM 3/8	350 bars	30 litres/min	- €
ER 1/2	FEM 1/2	310 bars	45 litres/min	- €
ER 3/4	FEM 3/4	280 bars	85 litres/min	- €
ER 1"	FEM 1"	250 bars	150 litres/min	- €

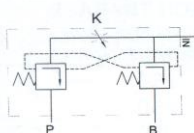

**REGULATEUR DE DEBIT COMPENSE**

REFERENCE	FILETAGE	PRESSION	DEBIT	TARIF
REGULATEUR RDC40	FEM 1/2	250 bars	40 litres/min	- €
REGULATEUR RDC70	FEM 3/4	250 bars	70 litres/min	- €
REGULATEUR RDC90	FEM 3/4	250 bars	90 litres/min	- €

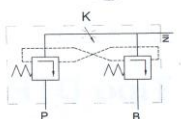

**REGULATEUR DE DEBIT COMPENSE AVEC LIMITEUR**

REFERENCE	FILETAGE	PRESSION	DEBIT	TARIF
REGULATEUR RDC40P	FEM 1/2	250 bars	40 litres/min	- €
REGULATEUR RDC70P	FEM 3/4	250 bars	70 litres/min	- €

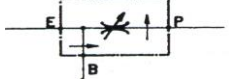

**REGULATEUR DE DEBIT COMPENSE**

REFERENCE	FILETAGE	PRESSION	DEBIT	TARIF
REGULATEUR VDC3/8	FEM 3/8	210 bars	55/30 litres/min	- €
REGULATEUR VDC1/2	FEM 1/2	210 bars	90/55 litres/min	- €
REGULATEUR VDC3/4	FEM 3/4	210 bars	150/90 litres/min	- €

**DIVISEUR DE DEBIT A 50%**

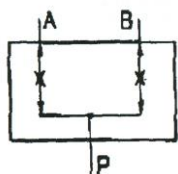

REFERENCE	FILETAGE	PRESSION	DEBIT	TARIF
DIVISEUR 03/06	FEM 3/8	250 bars	3-6 litres/min	- €
DIVISEUR 06/10	FEM 3/8	250 bars	6-10 litres/min	- €
DIVISEUR 10/20	FEM 3/8	250 bars	10-20 litres/min	- €
DIVISEUR 20/32	FEM 3/8	250 bars	20-32 litres/min	- €
DIVISEUR 25/40	FEM 1/2	250 bars	25-40 litres/min	- €
DIVISEUR 40/60	FEM 1/2	250 bars	40-60 litres/min	- €
DIVISEUR 60/90	FEM 3/4	210 bars	60-90 litres/min	- €
DIVISEUR 90/150	FEM 1"	210 bars	90-150 litres/min	- €

**LIMITEUR DE PRESSION EN LIGNE ACIER 350 BARS**

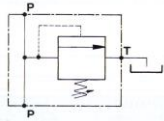

REFERENCE	FILETAGE	PRESSION	DEBIT	TARIF
LP ACIER 3/8	FEM 3/8	80-300 bars	45 litres/min	- €
LP ACIER 1/2	FEM 1/2	80-300 bars	70 litres/min	- €
LP ACIER 3/4	FEM 3/4	80-300 bars	120 litres/min	- €
LP ACIER 1"	FEM 1"	50-350 bars	180 litres/min	- €

**LIMITEUR DE PRESSION EN LIGNE ALU 220 BARS**

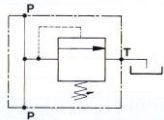

REFERENCE	FILETAGE	PRESSION	DEBIT	TARIF
LP ALU 3/8-40L-5/50	FEM 3/8	5-50 bars	40 litres/min	- €
LP ALU 3/8-40L-30/100	FEM 3/8	30-100 bars	40 litres/min	- €
LP ALU 3/8-40L-50/220	FEM 3/8	50-220 bars	40 litres/min	- €
LP ALU 1/2-40L-5/50	FEM 1/2	5-50 bars	40 litres/min	- €
LP ALU 1/2-40L-30/100	FEM 1/2	30-100 bars	40 litres/min	- €
LP ALU 1/2-40L-50/220	FEM 1/2	50-220 bars	40 litres/min	- €
LP ALU 1/2-80L-5/50	FEM 1/2	5-50 bars	80 litres/min	- €
LP ALU 1/2-80L-30/100	FEM 1/2	30-100 bars	80 litres/min	- €
LP ALU 1/2-80L-50/220	FEM 1/2	50-220 bars	80 litres/min	- €
LP ALU 3/4-80L-5/50	FEM 3/4	5-50 bars	80 litres/min	- €
LP ALU 3/4-80L-30/100	FEM 3/4	30-100 bars	80 litres/min	- €
LP ALU 3/4-80L-50/220	FEM 3/4	50-220 bars	80 litres/min	- €

**LIMITEUR DE PRESSION EN LIGNE ALU 220 BARS  
REGULATION PAR VOLANT**

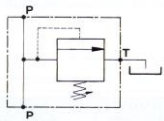

REFERENCE	FILETAGE	PRESSION	DEBIT	TARIF
LP ALU VOLANT 3/8-40L-5/50	FEM 3/8	5-50 bars	40 litres/min	- €
LP ALU VOLANT 3/8-40L-30/100	FEM 3/8	30-100 bars	40 litres/min	- €
LP ALU VOLANT 3/8-40L-50/220	FEM 3/8	50-220 bars	40 litres/min	- €
LP ALU VOLANT 1/2-40L-5/50	FEM 1/2	5-50 bars	40 litres/min	- €
LP ALU VOLANT 1/2-40L-30/100	FEM 1/2	30-100 bars	40 litres/min	- €
LP ALU VOLANT 1/2-40L-50/220	FEM 1/2	50-220 bars	40 litres/min	- €
LP ALU VOLANT 1/2-80L-5/50	FEM 1/2	5-50 bars	80 litres/min	- €
LP ALU VOLANT 1/2-80L-30/100	FEM 1/2	30-100 bars	80 litres/min	- €
LP ALU VOLANT 1/2-80L-50/220	FEM 1/2	50-220 bars	80 litres/min	- €
LP ALU VOLANT 3/4-80L-5/50	FEM 3/4	5-50 bars	80 litres/min	- €
LP ALU VOLANT 3/4-80L-30-100	FEM 3/4	30-100 bars	80 litres/min	- €
LP ALU VOLANT 3/4-80L-50/220	FEM 3/4	50-220 bars	80 litres/min	- €

**CLAPET ANTI - RETOUR ( TARAGE 0,5 BARS )**

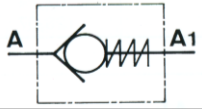

REFERENCE	FILETAGE	PRESSION	DEBIT	TARIF
CAR 1/4 FF	FEM 1/4	350 bars	12 litres/min	- €
CAR 3/8 FF	FEM 3/8	350 bars	30 litres/min	- €
CAR 1/2 FF	FEM 1/2	350 bars	45 litres/min	- €
CAR 3/4 FF	FEM 3/4	300 bars	85 litres/min	- €
CAR 1" FF	FEM 1"	250 bars	140 litres/min	- €
CAR 1"1/4 FF	FEM 1"1/4	250 bars	200 litres/min	- €
CAR 1"1/2 FF	FEM 1"1/2	210 bars	310 litres/min	- €

**ANTI - RETOUR NU**

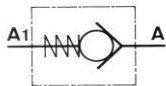

REFERENCE	FILETAGE	PRESSION	DEBIT	TARIF
AR 1/4	MALE 1/4	350 bars	15 litres/min	- €
AR 3/8	MALE 3/8	350 bars	30 litres/min	- €
AR 1/2	MALE 1/2	350 bars	45 litres/min	- €
AR 3/4	MALE 3/4	300 bars	80 litres/min	- €

**CLAPET ANTI - RETOUR SIMPLE PILOTE**

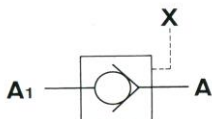

REFERENCE	FILETAGE	PRESSION	DEBIT	TARIF
CAR SP 1/4 FF	FEM 1/4	350 bars	12 litres/min	- €
CAR SP 3/8 FF	FEM 3/8	310 bars	30 litres/min	- €
CAR SP 1/2 FF	FEM 1/2	310 bars	45 litres/min	- €
CAR SP 3/4 FF	FEM 3/4	300 bars	80 litres/min	- €

**VALVE ANTI - RETOUR SIMPLE PILOTE**

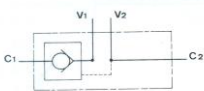

REFERENCE	FILETAGE	PRESSION	DEBIT	TARIF
CARD SE 1/4	FEM 1/4	350 bars	12 litres/min	- €
CARD SE 14-3/8	FEM 3/8	300 bars	20 litres/min	- €
CARD SE 3/8	FEM 3/8	300 bars	30 litres/min	- €
CARD SE 1/2	FEM 1/2	300 bars	45 litres/min	- €
CARD SE 3/4	FEM 3/4	280 bars	85 litres/min	- €

**VALVE ANTI - RETOUR DOUBLE PILOTE**

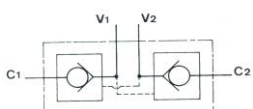

REFERENCE	FILETAGE	PRESSION	DEBIT	TARIF
CARD DE 1/4	FEM 1/4	350 bars	12 litres/min	- €
CARD DE 14-3/8	FEM 3/8	300 bars	20 litres/min	- €
CARD DE 3/8	FEM 3/8	300 bars	30 litres/min	- €
CARD DE 1/2	FEM 1/2	300 bars	45 litres/min	- €
CARD DE 3/4	FEM 3/4	280 bars	85 litres/min	- €

**CLAPET PARACHUTE FEMELLE/FEMELLE**

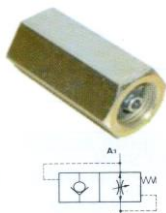

REFERENCE	FILETAGE	PRESSION	DEBIT	TARIF
CP 1/4 FF	FEM 1/4	350 bars	25 litres/min	- €
CP 3/8 FF	FEM 3/8	350 bars	50 litres/min	- €
CP 1/2 FF	FEM 1/2	350 bars	80 litres/min	- €
CP 3/4 FF	FEM 3/4	350 bars	150 litres/min	- €
CP 1" FF	FEM 1"	300 bars	200 litres/min	- €

**CLAPET PARACHUTE MALE/FEMELLE**

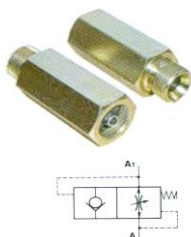

REFERENCE	FILETAGE	PRESSION	DEBIT	TARIF
CP 1/4 MF	MALE/FEM 1/4	350 bars	25 litres/min	- €
CP 3/8 MF	MALE/FEM 3/8	350 bars	50 litres/min	- €
CP 1/2 MF	MALE/FEM 1/2	350 bars	80 litres/min	- €
CP 3/4 MF	MALE/FEM 3/4	350 bars	150 litres/min	- €
CP 1" MF	MALE/FEM 1"	300 bars	200 litres/min	- €

**PARACHUTE NU**

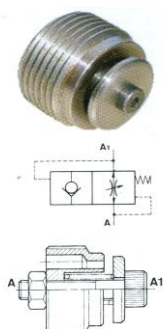

REFERENCE	FILETAGE	PRESSION	DEBIT	TARIF
PARACHUTE 1/4	MALE 1/4	350 bars	25 litres/min	- €
PARACHUTE 3/8	MALE 3/8	350 bars	50 litres/min	- €
PARACHUTE 1/2	MALE 1/2	350 bars	80 litres/min	- €
PARACHUTE 3/4	MALE 3/4	350 bars	150 litres/min	- €
PARACHUTE 1"	MALE 1"	300 bars	200 litres/min	- €

**SELECTEUR DE CIRCUIT A BILLE**

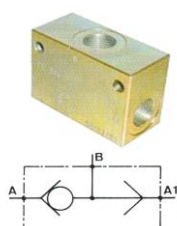

REFERENCE	FILETAGE	PRESSION	DEBIT	TARIF
VSF 1/4	FEM 1/4	350 bars	25 litres/min	- €
VSF 3/8	FEM 3/8	350 bars	50 litres/min	- €
VSF 1/2	FEM 1/2	350 bars	80 litres/min	SD

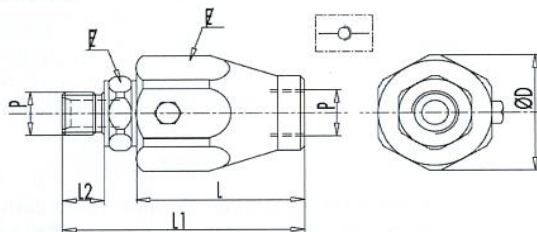
**RACCORD TOURNANT MBSP X FG DROIT**

REFERENCE	FILETAGE	PRESSION MAX	PRESSION MAX EN ROTATION	DEBIT	TAILLE L1 X D	TARIF
RACC TOURNANT MBSP1/4XFG1/4	G1/4	400 bars	200 bars	25 litres/min	61x33mm	- €
RACC TOURNANT MBSP3/8XFG3/8	G3/8	400 bars	200 bars	35 litres/min	66x37mm	- €
RACC TOURNANT MBSP1/2XFG1/2	G1/2	300 bars	150 bars	60 litres/min	71x40mm	- €
RACC TOURNANT MBSP3/4XFG3/4	G3/4	300 bars	150 bars	100 litres/min	80x49mm	- €
RACC TOURNANT MBSP1"XFG1"	G1"	300 bars	100 bars	180 litres/min	90x54,5mm	- €
RACC TOURNANT MBSP1"1/4XFG1"1/4	G1"1/4	300 bars	100 bars		101x60mm	- €
RACC TOURNANT MBSP1"1/2XFG1"1/2	G1"1/2	300 bars	80 bars		110x69,5mm	- €
RACC TOURNANT MBSP2"XFG2"	G2"	250 bars	50 bars		118x84,5mm	- €

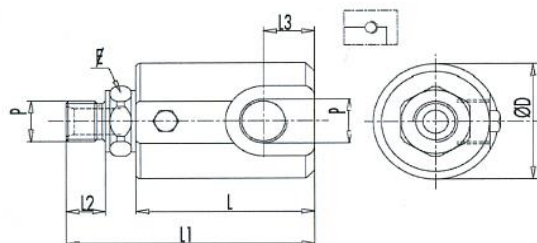
**RACCORD TOURNANT MBSP X FG 90°**

REFERENCE	FILETAGE	PRESSION MAX	PRESSION MAX EN ROTATION	DEBIT	TAILLE L1 X D	TARIF
RACC TOURNANT MBSP1/4XFG1/4 90°	G1/4	400 bars	200 bars	25 litres/min	69x34mm	- €
RACC TOURNANT MBSP3/8XFG3/8 90°	G3/8	400 bars	200 bars	35 litres/min	76x38mm	- €
RACC TOURNANT MBSP1/2XFG1/2 90°	G1/2	300 bars	150 bars	60 litres/min	87x40mm	- €
RACC TOURNANT MBSP3/4XFG3/4 90°	G3/4	300 bars	150 bars	100 litres/min	100x55mm	- €
RACC TOURNANT MBSP1"XFG1" 90°	G1"	300 bars	100 bars	180 litres/min	113x60mm	- €
RACC TOURNANT MBSP1"1/4XFG1"1/4 90°	G1"1/4	300 bars	100 bars		121x77mm	- €
RACC TOURNANT MBSP1"1/2XFG1"1/2 90°	G1"1/2	300 bars	80 bars		143x85mm	- €
RACC TOURNANT MBSP2"XFG2" 90°	G2"	250 bars	50 bars		151x97mm	- €



**CREPINE D'ASPIRATION 125 MICRONS**

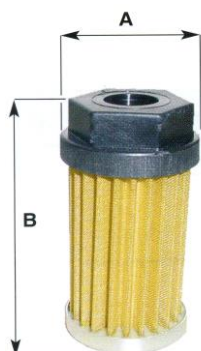

REFERENCE	FILETAGE	TAILLE AxB	DEBIT	TARIF
CEPINE T125-G3/8	FEM 3/8	46x90mm	15 litres/min	- €
CEPINE T125-G1/2	FEM 1/2	46x105mm	35 litres/min	- €
CEPINE T125-G3/4	FEM 3/4	64x109mm	52 litres/min	- €
CEPINE T125-G1"/A	FEM 1"	64x139mm	100 litres/min	- €
CEPINE T125-G1"/B	FEM 1"	86x139mm	125 litres/min	- €
CEPINE T125-G1"1/4	FEM 1"1/4	86x139mm	160 litres/min	- €
CEPINE T125-G1"1/2/A	FEM 1"1/2	86x139mm	180 litres/min	- €
CEPINE T125-G1"1/2/B	FEM 1"1/2	86x200mm	215 litres/min	- €
CEPINE T125-G1"1/2/C	FEM 1"1/2	150x151mm	230 litres/min	- €
CEPINE T125-G2"/A	FEM 2"	86x260mm	280 litres/min	- €
CEPINE T125-G2"/B	FEM 2"	150x151mm	270 litres/min	- €
CEPINE T125-G2"1/2	FEM 2"1/2	150x211mm	500 litres/min	- €
CEPINE T125-G3"	FEM 3"	150x272mm	500 litres/min	- €

**SUPPORT FILTRE A L'ASPIRATION**

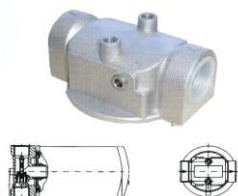

REFERENCE	FILETAGE	CARTOUCHE	DEBIT	TARIF
SUPPORT FILTRE SOA 3/4	FEM 3/4	SOE 3/4		- €
SUPPORT FILTRE SOA 1"1/4	FEM 1"1/4	SOE 1"1/4		- €
SUPPORT FILTRE SOA 1"1/4 DOUBLE	FEM 1"1/2	SOE 1"1/4		- €

**SUPPORT FILTRE AU RETOUR**

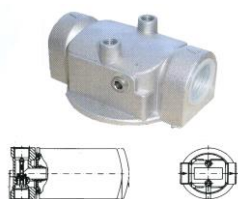

REFERENCE	FILETAGE	CARTOUCHE	DEBIT	TARIF
SUPPORT FILTRE SOR 3/4	FEM 3/4	SOE 3/4		- €
SUPPORT FILTRE SOR 1"1/4	FEM 1"1/4	SOE 1"1/4		- €
SUPPORT FILTRE SOR 1"1/4 DOUBLE	FEM 1"1/2	SOE 1"1/4		- €

**CARTOUCHE FILTRE A VISSER**



REFERENCE	FILETAGE		DEBIT	TARIF
CARTOUCHE FILTRE SOE 3/4-P10	FEM 3/4			- €
CARTOUCHE FILTRE SOE 3/4-P25	FEM 3/4			- €
CARTOUCHE FILTRE SOE 3/4-M60	FEM 3/4			- €
CARTOUCHE FILTRE SOE 3/4-M125	FEM 3/4			- €
CARTOUCHE FILTRE SOE 1"1/4-P10	FEM 1"1/4			- €
CARTOUCHE FILTRE SOE 1"1/4-P25	FEM 1"1/4			- €
CARTOUCHE FILTRE SOE 1"1/4-M60	FEM 1"1/4			- €
CARTOUCHE FILTRE SOE 1"1/4-M125	FEM 1"1/4			- €

CIHAL - Techopole de Forbach Sud

113 RUE ROBERT BUNSEN- 57460 BEHREN LES FORBACH  
 TEL 03 87 81 51 33 - FAX 03 87 81 22 38 - E-mail: magasin@cihal.fr

**FILTRE SEMI-IMMERGE RETOUR**



REFERENCE	FILETAGE		TARIF
FILTRE FR10-G1/2	FEM 1/2		- €
FILTRE FR20-G1/2	FEM 1/2		- €
FILTRE FR20-G3/4	FEM 3/4		- €
FILTRE FR22-G3/4	FEM 3/4		- €
FILTRE FR22-G1"	FEM 1"		- €
FILTRE FR40-G1"	FEM 1"		- €
FILTRE FR40-G1"1/4	FEM 1"1/4		- €
FILTRE FR50-G1"1/4	FEM 1"1/4		- €
FILTRE FR50-G1"1/2	FEM 1"1/2		- €
FILTRE FR51-G1"1/2	FEM 1"1/2		- €
FILTRE FR60-G1"1/2	FEM 1"1/2		- €
FILTRE FR60-G2"	FEM 2"		- €
FILTRE FR64-G2"	FEM 2"		- €

**CARTOUCHE POUR FILTRE SEMI-IMMERGE**



REFERENCE	FILTRATION	d X D	I X L	TARIF
CARTOUCHE FILTRE FR10-C10	PAPIER 10μ	25x50mm	70x76mm	- €
CARTOUCHE FILTRE FR20-C10	PAPIER 10μ	29x70mm	80x86mm	- €
CARTOUCHE FILTRE FR22-C10	PAPIER 10μ	29x70mm	130x136mm	- €
CARTOUCHE FILTRE FR40-C10	PAPIER 10μ	41x99mm	206x214mm	- €
CARTOUCHE FILTRE FR50-C10	PAPIER 10μ	51x130mm	141x150mm	- €
CARTOUCHE FILTRE FR51-C10	PAPIER 10μ	52x130mm	200x209mm	- €
CARTOUCHE FILTRE FR60-C10	PAPIER 10μ	65x130mm	200x209mm	- €
CARTOUCHE FILTRE FR64-C10	PAPIER 10μ	65x130mm	250x259mm	- €
CARTOUCHE FILTRE FR10-C25	PAPIER 25μ	25x50mm	70x76mm	- €
CARTOUCHE FILTRE FR20-C25	PAPIER 25μ	29x70mm	80x86mm	- €
CARTOUCHE FILTRE FR22-C25	PAPIER 25μ	29x70mm	130x136mm	- €
CARTOUCHE FILTRE FR40-C25	PAPIER 25μ	41x99mm	206x214mm	- €
CARTOUCHE FILTRE FR50-C25	PAPIER 25μ	51x130mm	141x150mm	- €
CARTOUCHE FILTRE FR51-C25	PAPIER 25μ	52x130mm	200x209mm	- €
CARTOUCHE FILTRE FR60-C25	PAPIER 25μ	65x130mm	200x209mm	- €
CARTOUCHE FILTRE FR64-C25	PAPIER 25μ	65x130mm	250x259mm	- €
CARTOUCHE FILTRE FR10-M60	METAL 60μ	25x50mm	70x76mm	- €
CARTOUCHE FILTRE FR20-M60	METAL 60μ	29x70mm	80x86mm	- €
CARTOUCHE FILTRE FR22-M60	METAL 60μ	29x70mm	130x136mm	- €
CARTOUCHE FILTRE FR40-M60	METAL 60μ	41x99mm	206x214mm	- €
CARTOUCHE FILTRE FR50-M60	METAL 60μ	51x130mm	141x150mm	- €
CARTOUCHE FILTRE FR51-M60	METAL 60μ	52x130mm	200x209mm	- €
CARTOUCHE FILTRE FR60-M60	METAL 60μ	65x130mm	200x209mm	- €
CARTOUCHE FILTRE FR64-M60	METAL 60μ	65x130mm	250x259mm	- €
CARTOUCHE FILTRE FR10-M125	METAL 125μ	25x50mm	70x76mm	- €
CARTOUCHE FILTRE FR20-M125	METAL 125μ	29x70mm	80x86mm	- €
CARTOUCHE FILTRE FR22-M125	METAL 125μ	29x70mm	130x136mm	- €
CARTOUCHE FILTRE FR40-M125	METAL 125μ	41x99mm	206x214mm	- €
CARTOUCHE FILTRE FR50-M125	METAL 125μ	51x130mm	141x150mm	- €
CARTOUCHE FILTRE FR51-M125	METAL 125μ	52x130mm	200x209mm	- €
CARTOUCHE FILTRE FR60-M125	METAL 125μ	65x130mm	200x209mm	- €
CARTOUCHE FILTRE FR64-M125	METAL 125μ	65x130mm	250x259mm	- €

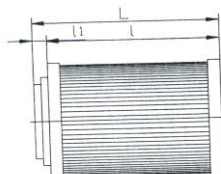
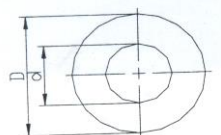

CIHAL - Technopôle de Forbach Sud

113 RUE ROBERT BUNSEN- 57460 BEHREN LES FORBACH  
 TEL 03 87 81 51 33 - FAX 03 87 81 22 38 - E-mail: magasin@cihal.fr

**CONTROLE DE COLMATAGE DES FILTRES**



REFERENCE	FILETAGE	PRESSION	TARIF
VACUOMETRE COULEUR MG1/8 -1/0	MALE 1/8	-1 à 0 BARS	- €
MANOMETRE COULEUR MG1/8 0/6	MALE 1/8	0 à 6 BARS	- €



### VOYANT DE NIVEAU SANS THERMOMETRE

REFERENCE	FILETAGE	ENTRAXE	TARIF
VOYANT NIVEAU FL76	M10	76mm	- €
VOYANT NIVEAU FL127	M12	127mm	- €
VOYANT NIVEAU FL254	M12	254mm	- €



### VOYANT DE NIVEAU AVEC THERMOMETRE

REFERENCE	FILETAGE	ENTRAXE	TARIF
VOYANT NIVEAU FL76T	M10	76mm	- €
VOYANT NIVEAU FL127T	M12	127mm	- €
VOYANT NIVEAU FL254T	M12	254mm	- €

### VOYANT DE NIVEAU FILETE MALE GAZ



REFERENCE	FILETAGE		TARIF
VOYANT NIVEAU TLG1/4	MG1/4		- €
VOYANT NIVEAU TLG3/8	MG3/8		- €
VOYANT NIVEAU TLG1/2	MG1/2		- €
VOYANT NIVEAU TLG3/4	MG3/4		- €
VOYANT NIVEAU TLG1"	MG1"		- €
VOYANT NIVEAU TLG1"1/4	MG1"1/4		- €
VOYANT NIVEAU TLG1"1/2	MG1"1/2		- €
VOYANT NIVEAU TLG2"	MG2"		- €

### VOYANT DE NIVEAU FILETE MALE METRIQUE



REFERENCE	FILETAGE		TARIF
VOYANT NIVEAU TLM14X150	M14X150		- €
VOYANT NIVEAU TLM16X150	M16X150		- €
VOYANT NIVEAU TLM22X150	M22X150		- €
VOYANT NIVEAU TLM24X150	M24X150		- €
VOYANT NIVEAU TLM27X150	M27X150		- €
VOYANT NIVEAU TLM30X150	M30X150		- €
VOYANT NIVEAU TLM33X150	M33X150		- €

**BOUCHON RENIFLARD MALE GAZ**



REFERENCE	FILETAGE	ENTRAXE	TARIF
BOUCHON RENIFLARD FA1/4	MG1/4		- €
BOUCHON RENIFLARD FA3/8	MG3/8		- €
BOUCHON RENIFLARD FA1/2	MG1/2		- €
BOUCHON RENIFLARD FA3/4	MG3/4		- €
BOUCHON RENIFLARD FA1"	MG1"		- €

**BOUCHON RENIFLARD AVEC CREPINE 40µ**



REFERENCE	FILETAGE	ENTRAXE	TARIF
BOUCHON RENIFLARD FA			- €
BOUCHON RENIFLARD FA			- €
BOUCHON RENIFLARD FA			- €

**BOUCHON RENIFLARD ACIER MALE GAZ**



REFERENCE	FILETAGE	ENTRAXE	TARIF
BOUCHON RENIFLARD TST1/4	MG1/4		- €
BOUCHON RENIFLARD TST3/8	MG3/8		- €
BOUCHON RENIFLARD TST1/2	MG1/2		- €
BOUCHON RENIFLARD TST3/4	MG3/4		- €
BOUCHON RENIFLARD TST1"	MG1"		- €
BOUCHON RENIFLARD TSF1"1/4	MG1"1/4		- €
BOUCHON RENIFLARD TSF1"1/2	MG1"1/2		- €

**BOUCHON RENIFLARD ACIER AVEC PURGE**



REFERENCE	FILETAGE	ENTRAXE	TARIF
BOUCHON RENIFLARD TSP1/4	MG1/4		- €
BOUCHON RENIFLARD TSP3/8	MG3/8		- €
BOUCHON RENIFLARD TSP1/2	MG1/2		- €
BOUCHON RENIFLARD TSP3/4	MG3/4		- €
BOUCHON RENIFLARD TSP1"	MG1"		- €

**BOUCHON ACIER MAGNETIQUE MALE GAZ**



REFERENCE	FILETAGE	ENTRAXE	TARIF
BOUCHON TSM1/4	MG1/4		- €
BOUCHON TSM3/8	MG3/8		- €
BOUCHON TSM1/2	MG1/2		- €
BOUCHON TSM3/4	MG3/4		- €
BOUCHON TSM1"	MG1"		- €
BOUCHON TSM1"1/4	MG1"1/4		- €
BOUCHON TSM1"1/2	MG1"1/2		SD

### MULTIPLICATEUR POUR POMPES ENGRENAGE

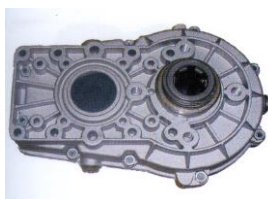

REFERENCE	ARBRE	RAPPORT	TARIF
MULTIPLICATEUR GR2 FEMELL	24,7mm-14dents	1 / 3,35	- €
MULTIPLICATEUR GR2 MALE	24,7mm-14dents	1 / 3,38	- €
MULTIPLICATEUR GR3 FEMELL	34,5mm-18dents	1 / 3,35	- €
MULTIPLICATEUR GR3 MALE	34,5mm-18dents	1 / 3,38	- €

### NOIX D'ACCOUPEMENT POUR POMPES ENGRE.

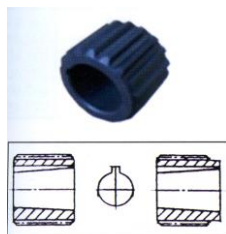

REFERENCE	DIAM. EXT.	DIAM. INT.	TARIF
NOIX GR1/GR2	24,7mm-14dents	CON 1/8 - GR1	- €
NOIX GR2	24,7mm-14dents	CON 1/8 - GR2	- €
NOIX GR2/GR3	34,5mm-18dents	CON 1/8 - GR2	- €
NOIX GR3	34,5mm-18dents	CON 1/8 - GR3	- €

### CONTRE - PALIER POUR POMPES ENGRENAGE



REFERENCE	ARBRE EXT.	CHARGE AXIALE	TARIF
CONTRE-PALIER GR1	GR1 CYL. 18mm	100 Kgs/m	- €
CONTRE-PALIER GR1 CONIQUE	GR1 CONIQUE 1/8	100 Kgs/m	- €
CONTRE-PALIER GR2	GR2 CYL. 18mm	170 Kgs/m	- €
CONTRE-PALIER GR2 CONIQUE	GR2 CONIQUE 1/8	170 Kgs/m	- €
CONTRE-PALIER GR3	GR3 CYL. 24mm	320 Kgs/m	- €
CONTRE-PALIER GR3 CONIQUE	GR3 CONIQUE 1/8	320 Kgs/m	- €

### LANTERNE D'ACCOUPEMENT ALU



REFERENCE	POUR MOTEUR	DIAM. LANTERNE	TARIF
LANTERNE GR1-160	0,3-0,5 CV	160mm	- €
LANTERNE GR1-200	0,75-2 CV	200mm	- €
LANTERNE GR1-250	3-5,5 CV	250mm	- €
LANTERNE GR2-200	0,75-2 CV	200mm	- €
LANTERNE GR2-250	3-5,5 CV	250mm	- €
LANTERNE GR2-300	7,5-12,5 CV	300mm	- €
LANTERNE GR2-350	15-30 CV	350mm	- €
LANTERNE GR3-250	3-5,5 CV	250mm	- €
LANTERNE GR3-300	7,5-12,5 CV	300mm	- €
LANTERNE GR3-350	15-30 CV	350mm	- €



**ACCOUPLLEMENT ELASTIQUE EUROPEEN**



REFERENCE	POUR MOTEUR	ARBRE MOTEUR	TARIF
ACCOUPLLEMENT GR1-42/14	0,3-0,5 CV	14mm	- €
ACCOUPLLEMENT GR1-42/19	0,75-1 CV	19mm	- €
ACCOUPLLEMENT GR1-59/24	1,5-2 CV	24mm	- €
ACCOUPLLEMENT GR1-59/28	3-5,5 CV	28mm	- €
ACCOUPLLEMENT GR2-59/19	0,75-1 CV	19mm	- €
ACCOUPLLEMENT GR2-59/24	1,5-2 CV	24mm	- €
ACCOUPLLEMENT GR2-59/28	3-5,5 CV	28mm	- €
ACCOUPLLEMENT GR2-79/38	7,5-12,5 CV	38mm	- €
ACCOUPLLEMENT GR2-99/42	15-20 CV	42mm	- €
ACCOUPLLEMENT GR3-79/28	3-5,5 CV	28mm	- €
ACCOUPLLEMENT GR3-79/38	7,5-12,5 CV	38mm	- €
ACCOUPLLEMENT GR3-99/42	15-20 CV	42mm	- €
ACCOUPLLEMENT GR3-99/48	25-30 CV	48mm	- €

**ETOILE POUR ACCOUPLLEMENT ELASTIQUE**



REFERENCE	MATIERE	DIAMETRE	TARIF
ACCOUPLLEMENT ETOILE 42	NBR 75 Shores	42mm	- €
ACCOUPLLEMENT ETOILE 59	NBR 75 Shores	59mm	- €
ACCOUPLLEMENT ETOILE 79	NBR 75 Shores	79mm	- €
ACCOUPLLEMENT ETOILE 99	NBR 75 Shores	99mm	- €

**VERIN DOUBLE EFFET**

Pression de service Max 210 bars

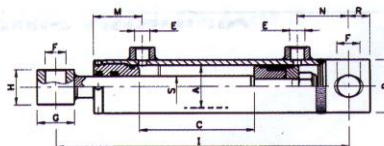
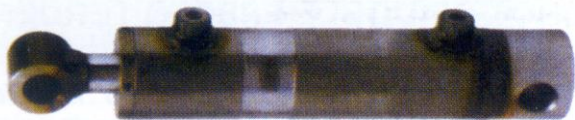

REFERENCE	FILETAGE	□ S	□ A	C	I	□ D	□ F	□ G	H	M	N	R	Kg/100Bars	TARIF
VERIN DE 20X32X50	FEM 1/4	20	32	50	205	40	16,4	28	35	43	38	17	800	- €
VERIN DE 20X32X100	FEM 1/4	20	32	100	255	40	16,4	28	35	43	38	17	800	- €
VERIN DE 20X32X150	FEM 1/4	20	32	150	305	40	16,4	28	35	43	38	17	800	- €
VERIN DE 20X32X200	FEM 1/4	20	32	200	355	40	16,4	28	35	43	38	17	800	- €
VERIN DE 20X32X250	FEM 1/4	20	32	250	405	40	16,4	28	35	43	38	17	800	- €
VERIN DE 20X32X300	FEM 1/4	20	32	300	455	40	16,4	28	35	43	38	17	800	- €
VERIN DE 25X40X100	FEM 3/8	25	40	100	270	50	20,5	35	40	43	45	19	1250	- €
VERIN DE 25X40X150	FEM 3/8	25	40	150	320	50	20,5	35	40	43	45	19	1250	- €
VERIN DE 25X40X200	FEM 3/8	25	40	200	370	50	20,5	35	40	43	45	19	1250	- €
VERIN DE 25X40X250	FEM 3/8	25	40	250	420	50	20,5	35	40	43	45	19	1250	- €
VERIN DE 25X40X300	FEM 3/8	25	40	300	470	50	20,5	35	40	43	45	19	1250	- €
VERIN DE 25X40X400	FEM 3/8	25	40	400	570	50	20,5	35	40	43	45	19	1250	- €
VERIN DE 25X40X500	FEM 3/8	25	40	500	670	50	20,5	35	40	43	45	19	1250	- €
VERIN DE 30X50X100	FEM 3/8	30	50	100	300	60	25,5	45	45	46	58	25	1960	- €
VERIN DE 30X50X150	FEM 3/8	30	50	150	350	60	25,5	45	45	46	58	25	1960	- €
VERIN DE 30X50X200	FEM 3/8	30	50	200	400	60	25,5	45	45	46	58	25	1960	- €
VERIN DE 30X50X250	FEM 3/8	30	50	250	450	60	25,5	45	45	46	58	25	1960	- €
VERIN DE 30X50X300	FEM 3/8	30	50	300	500	60	25,5	45	45	46	58	25	1960	- €
VERIN DE 30X50X400	FEM 3/8	30	50	400	600	60	25,5	45	45	46	58	25	1960	- €
VERIN DE 30X50X500	FEM 3/8	30	50	500	700	60	25,5	45	45	46	58	25	1960	- €
VERIN DE 30X50X600	FEM 3/8	30	50	600	800	60	25,5	45	45	46	58	25	1960	- €
VERIN DE 30X50X700	FEM 3/8	30	50	700	900	60	25,5	45	45	46	58	25	1960	- €
VERIN DE 30X50X800	FEM 3/8	30	50	800	1000	60	25,5	45	45	46	58	25	1960	- €
VERIN DE 30X60X100	FEM 3/8	30	60	100	300	70	25,5	45	45	51	58	25	2820	- €
VERIN DE 30X60X150	FEM 3/8	30	60	150	350	70	25,5	45	45	51	58	25	2820	- €
VERIN DE 30X60X200	FEM 3/8	30	60	200	400	70	25,5	45	45	51	58	25	2820	- €
VERIN DE 30X60X250	FEM 3/8	30	60	250	450	70	25,5	45	45	51	58	25	2820	- €
VERIN DE 30X60X300	FEM 3/8	30	60	300	500	70	25,5	45	45	51	58	25	2820	- €
VERIN DE 30X60X350	FEM 3/8	30	60	350	550	70	25,5	45	45	51	58	25	2820	- €
VERIN DE 30X60X400	FEM 3/8	30	60	400	600	70	25,5	45	45	51	58	25	2820	- €
VERIN DE 30X60X450	FEM 3/8	30	60	450	650	70	25,5	45	45	51	58	25	2820	- €
VERIN DE 30X60X500	FEM 3/8	30	60	500	700	70	25,5	45	45	51	58	25	2820	- €
VERIN DE 30X60X600	FEM 3/8	30	60	600	800	70	25,5	45	45	51	58	25	2820	- €
VERIN DE 30X60X700	FEM 3/8	30	60	700	900	70	25,5	45	45	51	58	25	2820	- €
VERIN DE 40X70X200	FEM 3/8	40	70	200	410	80	30,5	54	55	51	58	25	3840	- €
VERIN DE 40X70X250	FEM 3/8	40	70	250	460	80	30,5	54	55	51	58	25	3840	- €
VERIN DE 40X70X300	FEM 3/8	40	70	300	510	80	30,5	54	55	51	58	25	3840	- €
VERIN DE 40X70X350	FEM 3/8	40	70	350	560	80	30,5	54	55	51	58	25	3840	- €
VERIN DE 40X70X400	FEM 3/8	40	70	400	610	80	30,5	54	55	51	58	25	3840	- €
VERIN DE 40X70X450	FEM 3/8	40	70	450	660	80	30,5	54	55	51	58	25	3840	- €
VERIN DE 40X70X500	FEM 3/8	40	70	500	710	80	30,5	54	55	51	58	25	3840	- €
VERIN DE 40X70X600	FEM 3/8	40	70	600	810	80	30,5	54	55	51	58	25	3840	- €
VERIN DE 40X70X700	FEM 3/8	40	70	700	910	80	30,5	54	55	51	58	25	3840	- €
VERIN DE 40X80X200	FEM 3/8	40	80	200	410	92	30,5	54	55	62	58	25	5020	- €
VERIN DE 40X80X250	FEM 3/8	40	80	250	460	92	30,5	54	55	62	58	25	5020	- €
VERIN DE 40X80X300	FEM 3/8	40	80	300	510	92	30,5	54	55	62	58	25	5020	- €
VERIN DE 40X80X350	FEM 3/8	40	80	350	560	92	30,5	54	55	62	58	25	5020	- €
VERIN DE 40X80X400	FEM 3/8	40	80	400	610	92	30,5	54	55	62	58	25	5020	- €
VERIN DE 40X80X500	FEM 3/8	40	80	500	710	92	30,5	54	55	62	58	25	5020	- €
VERIN DE 40X80X600	FEM 3/8	40	80	600	810	92	30,5	54	55	62	58	25	5020	- €
VERIN DE 40X80X700	FEM 3/8	40	80	700	910	92	30,5	54	55	62	58	25	5020	- €

**VERIN DOUBLE EFFET**

Pression de service Max 210 bars

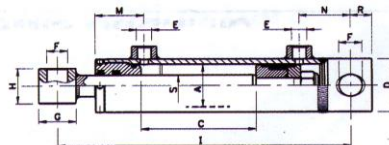

REFERENCE	FILETAGE	□ S	□ A	C	I	□ D	□ F	□ G	H	M	N	R	Kg/100Bars	TARIF
VERIN DE 50X100X300	FEM 3/8	50	100	300	546	115	30,5	54	70	81	60	34	7850	- €
VERIN DE 50X100X400	FEM 3/8	50	100	400	645	115	30,5	54	70	81	60	34	7850	- €
VERIN DE 50X100X500	FEM 3/8	50	100	500	745	115	30,5	54	70	81	60	34	7850	- €
VERIN DE 50X100X700	FEM 3/8	50	100	700	945	115	30,5	54	70	81	60	34	7850	- €
VERIN DE 50X100X900	FEM 3/8	50	100	900	1145	115	30,5	54	70	81	60	34	7850	- €
VERIN DE 70X120X500	FEM 1/2	70	120	500	770	140	40,5	70	80	81	65	40	11300	- €
VERIN DE 70X120X1000	FEM 1/2	70	120	1000	1270	140	40,5	70	80	81	65	40	11300	- €

**VERIN SIMPLE EFFET**

Pression de service Max 210 bars

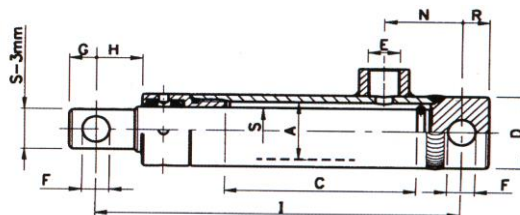

REFERENCE	FILETAGE	□ S	□ A	C	I	□ D	□ F	□ G	H	M	N	R	Kg/100Bars	TARIF
VERIN SE 32X100	FEM 3/8	25	32	100	190	40	14,2	14	24		40	14	800	- €
VERIN SE 32X150	FEM 3/8	25	32	150	240	40	14,2	14	24		40	14	800	- €
VERIN SE 32X200	FEM 3/8	25	32	200	290	40	14,2	14	24		40	14	800	- €
VERIN SE 32X250	FEM 3/8	25	32	250	340	40	14,2	14	24		40	14	800	- €
VERIN SE 32X300	FEM 3/8	25	32	300	390	40	14,2	14	24		40	14	800	- €
VERIN SE 40X150	FEM 3/8	30	40	150	250	50	16,4	16	26		44	15	1250	- €
VERIN SE 40X200	FEM 3/8	30	40	200	300	50	16,4	16	26		44	15	1250	- €
VERIN SE 40X250	FEM 3/8	30	40	250	350	50	16,4	16	26		44	15	1250	- €
VERIN SE 40X300	FEM 3/8	30	40	300	400	50	16,4	16	26		44	15	1250	- €
VERIN SE 40X350	FEM 3/8	30	40	350	450	50	16,4	16	26		44	15	1250	- €
VERIN SE 40X400	FEM 3/8	30	40	400	500	50	16,4	16	26		44	15	1250	- €
VERIN SE 40X450	FEM 3/8	30	40	450	550	50	16,4	16	26		44	15	1250	- €
VERIN SE 40X550	FEM 3/8	30	40	550	650	50	16,4	16	26		44	15	1250	- €
VERIN SE 40X700	FEM 3/8	30	40	700	800	50	16,4	16	26		44	15	1250	- €
VERIN SE 50X200	FEM 3/8	40	50	200	330	60	22,4	22	32		48	22	1960	- €
VERIN SE 50X250	FEM 3/8	40	50	250	380	60	22,4	22	32		48	22	1960	- €
VERIN SE 50X300	FEM 3/8	40	50	300	430	60	22,4	22	32		48	22	1960	- €
VERIN SE 50X350	FEM 3/8	40	50	350	480	60	22,4	22	32		48	22	1960	- €
VERIN SE 50X400	FEM 3/8	40	50	400	530	60	22,4	22	32		48	22	1960	- €
VERIN SE 50X450	FEM 3/8	40	50	450	580	60	22,4	22	32		48	22	1960	- €
VERIN SE 50X500	FEM 3/8	40	50	500	630	60	22,4	22	32		48	22	1960	- €
VERIN SE 50X550	FEM 3/8	40	50	550	680	60	22,4	22	32		48	22	1960	- €
VERIN SE 50X600	FEM 3/8	40	50	600	730	60	22,4	22	32		48	22	1960	- €
VERIN SE 50X700	FEM 3/8	40	50	700	830	60	22,4	22	32		48	22	1960	- €

**VERIN SIMPLE EFFET AVEC TETE**

Pression de service Max 210 bars

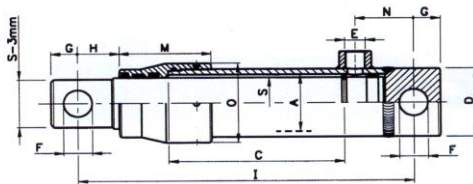

REFERENCE	FILETAGE	□ S	□ A	C	I	□ D	□ F	G	H	M	N	O	Kg/100Bars	TARIF
VERIN SER 50X200	FEM 3/8	45	50	200	330	60	23,4	22	34	75	47	70	1960	- €
VERIN SER 50X300	FEM 3/8	45	50	300	430	60	23,4	22	34	75	47	70	1960	- €
VERIN SER 50X400	FEM 3/8	45	50	400	530	60	23,4	22	34	75	47	70	1960	- €
VERIN SER 50X550	FEM 3/8	45	50	550	680	60	23,4	22	34	75	47	70	1960	- €
VERIN SER 50X700	FEM 3/8	45	50	700	830	60	23,4	22	34	75	47	70	1960	- €
VERIN SER 55X200	FEM 3/8	50	55	200	360	65	25,5	25	49	80	50	75	2380	- €
VERIN SER 55X300	FEM 3/8	50	55	300	460	65	25,5	25	49	80	50	75	2380	- €
VERIN SER 55X400	FEM 3/8	50	55	400	560	65	25,5	25	49	80	50	75	2380	- €
VERIN SER 55X550	FEM 3/8	50	55	550	710	65	25,5	25	49	80	50	75	2380	- €
VERIN SER 55X700	FEM 3/8	50	55	700	860	65	25,5	25	49	80	50	75	2380	- €
VERIN SER 60X300	FEM 3/8	55	60	300	460	70	25,5	25	41	95	50	85	2820	- €
VERIN SER 60X550	FEM 3/8	55	60	550	710	70	25,5	25	41	95	50	85	2820	- €
VERIN SER 60X700	FEM 3/8	55	60	700	860	70	25,5	25	41	95	50	85	2820	- €
VERIN SER 65X200	FEM 3/8	60	65	200	360	75	25,5	25	36	95	50	89	3310	- €
VERIN SER 65X300	FEM 3/8	60	65	300	460	75	25,5	25	36	95	50	89	3310	- €
VERIN SER 65X400	FEM 3/8	60	65	400	560	75	25,5	25	36	95	50	89	3310	- €
VERIN SER 65X550	FEM 3/8	60	65	550	710	75	25,5	25	36	95	50	89	3310	- €
VERIN SER 65X700	FEM 3/8	60	65	700	860	75	25,5	25	36	95	50	89	3310	- €

**VERIN 3ème POINT DOUBLE EFFET**

Pression de service Max 210 bars

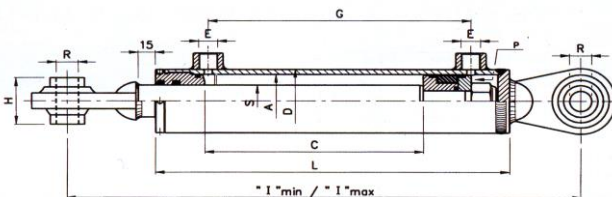

REFERENCE	FILETAGE	□ S	□ A	C	Imin	Imax	L	□ D	□ G	H	□ R	Kg/100Bars	TARIF
VERIN DEP 30X50X160/19	FEM 3/8	30	50	160	416	576	277	60	198	44	19,3	1960	- €
VERIN DEP 30X50X210/19	FEM 3/8	30	50	210	466	676	327	60	248	44	19,3	1960	- €
VERIN DEP 30X50X280/19	FEM 3/8	30	50	280	536	816	397	60	318	44	19,3	1960	- €
VERIN DEP 30X50X400/19	FEM 3/8	30	50	400	656	1056	517	60	438	44	19,3	1960	- €
VERIN DEP 30X50X160/25	FEM 3/8	30	50	160	426	586	277	60	198	51	25,3	1960	- €
VERIN DEP 30X50X210/25	FEM 3/8	30	50	210	476	686	327	60	248	51	25,3	1960	- €
VERIN DEP 30X50X280/25	FEM 3/8	30	50	280	546	826	397	60	318	51	25,3	1960	- €
VERIN DEP 30X50X400/25	FEM 3/8	30	50	400	666	1066	517	60	438	51	25,3	1960	- €
VERIN DEP 35X65X160/25	FEM 3/8	35	65	160	440	600	286	75	199	51	25,3	3310	- €
VERIN DEP 35X65X210/25	FEM 3/8	35	65	210	490	700	335	75	249	51	25,3	3310	- €
VERIN DEP 35X65X280/25	FEM 3/8	35	65	280	560	640	408	75	319	51	25,3	3310	- €
VERIN DEP 35X65X400/25	FEM 3/8	35	65	400	680	1080	526	75	439	51	25,3	3310	- €
VERIN DEP 40X80X160/25	FEM 3/8	40	80	160	461	621	312	92	210	51	25,3	5020	- €
VERIN DEP 40X80X210/25	FEM 3/8	40	80	210	511	721	362	92	260	51	25,3	5020	- €
VERIN DEP 40X80X280/25	FEM 3/8	40	80	280	581	861	432	92	330	51	25,3	5020	- €
VERIN DEP 40X80X400/25	FEM 3/8	40	80	400	701	1101	552	92	450	51	25,3	5020	- €

**OPTIONS POUR VERIN 3ème POINT**



REFERENCE	LONGUEUR	PRESSION	DEBIT	TARIF
CARD DE 38-12L	134mm	350 Bars	30 l/min	- €
TUBE BANJO 3/8-12L L42	42mm			- €
TUBE BANJO 3/8-12L L200	200mm			- €
TUBE BANJO 3/8-12L L300	300mm			- €
TUBE BANJO 3/8-12L L400	400mm			- €
TUBE BANJO 3/8-12L L500	500mm			- €

**ROTULES A SOUDER COTE TIGE ET COTE FUT**



REFERENCE	DIAMETRE												TARIF
ROTULE TIGE 19	19 mm												- €
ROTULE TIGE 20	20 mm												- €
ROTULE TIGE 25	25 mm												- €
ROTULE TIGE 30	30 mm												- €
ROTULE TIGE 35	35 mm												- €
RUTULE RIGE 40	40 mm												- €
ROTULE FUT 19	19 mm												- €
ROTULE FUT 22	22 mm												- €
ROTULE FUT 25	25 mm												- €
ROTULE FUT 28	28 mm												- €
ROTULE FUT 30	30 mm												- €
ROTULE FUT 35	35 mm												- €

**POMPE A MAIN SIMPLE EFFET AVEC RESERVOIR**

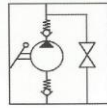

REFERENCE	P Max	Cylindrée	Reservoir	TARIF
POMPE A MAIN SE 22-3	220 bars	22 cc	3 litres	- €

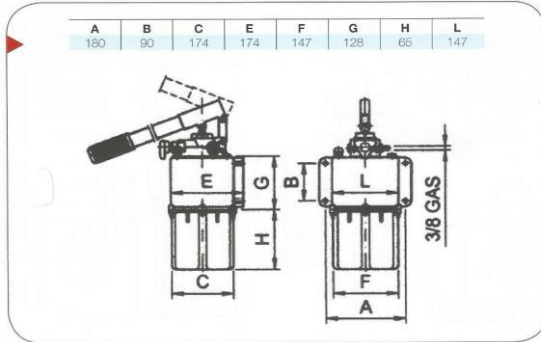

**POMPE A MAIN DOUBLE EFFET AVEC RESERVOIR**

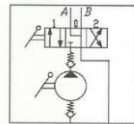

REFERENCE	P Max	Cylindrée	Reservoir	TARIF
POMPE A MAIN DE 25-5	280 bars	25 cc	5 litres	- €

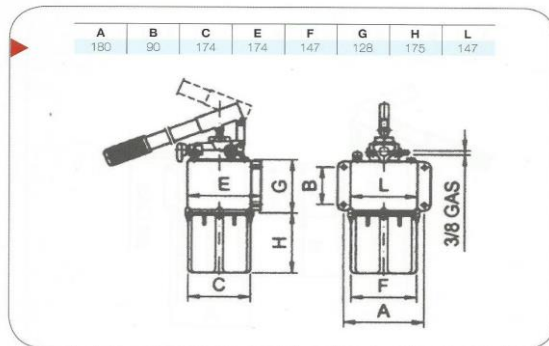

REFERENCE		LONGUEUR		TARIF
LEVIER POMPE A MAIN		600 mm		- €



**POMPE A MAIN SIMPLE EFFET POUR RESERVOIR SEPRE**



REFERENCE	P Max	Cylindrée	Reservoir	TARIF
POMPE A MAIN SES 20cc	280 bars	20 cc		- €
POMPE A MAIN SES 43cc	220 bars	43 cc		- €
POMPE A MAIN SES 69cc	170 bars	69 cc		- €

**POMPE A MAIN SIMPLE EFFET - MONTAGE SUR RESERVOIR**

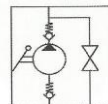

REFERENCE	P Max	Cylindrée	Reservoir	TARIF
POMPE A MAIN SER 6cc	320 bars	6 cc		- €
POMPE A MAIN SER 11cc	280 bars	11 cc		- €
POMPE A MAIN SER 22cc	220 bars	22 cc		- €

**POMPE A MAIN DOUBLE EFFET - MONTAGE SUR RESERVOIR**

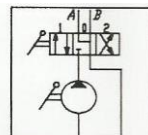

REFERENCE	P Max	Cylindrée	Reservoir	TARIF
POMPE A MAIN DER 12cc	320 bars	12 cc		- €
POMPE A MAIN DER 25cc	280 bars	25 cc		- €
POMPE A MAIN DER 45cc	220 bars	45 cc		- €

**POMPE A MAIN DOUBLE EFFET - MONTAGE SUR RESERVOIR  
AVEC ANTI-RETOUR**

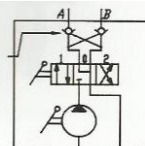

REFERENCE	P Max	Cylindrée	Reservoir	TARIF
POMPE A MAIN DERAR 12cc	320 bars	12 cc		- €
POMPE A MAIN DERAR 25cc	280 bars	25 cc		- €
POMPE A MAIN DERAR 45cc	220 bars	45 cc		- €

**RESERVOIR ALUMINIUM AVEC VOYANT DE NIVEAU**

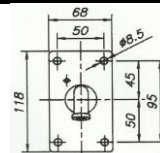

REFERENCE	P Max	Cylindrée	Reservoir	TARIF
RESERVOIR ALU PAM 2L VOYANT			2 litres	- €
RESERVOIR ALU PAM 3L VOYANT			3 litres	- €
RESERVOIR ALU PAM 5L VOYANT			5 litres	- €

**POMPE A ENGRENAGE - GROUPE 1 - STANDARD EUROPE - COLERETTE DIAMETRE 25 mm**

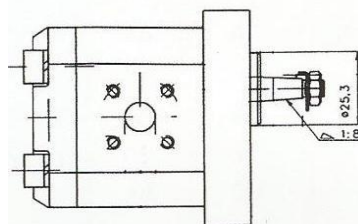
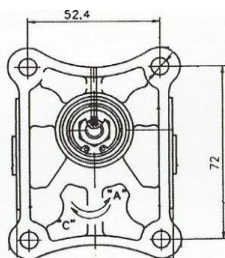

**ARBRE CONIQUE 1:8 - BRIDE BOCH**

	CYLIND. CC	PRESSION SERVICE	PRESSION MAX	ROTATION SERVICE	ROTATION MAX	BRIDES EUROPE	TARIF
POMPE GR1/0,7CC DROITE EUROPE D25	0,7	200 bars	250 bars	2000 tr/min	3500 tr/min	30X30mm	- €
POMPE GR1/1,1CC DROITE EUROPE D25	1,1	200 bars	250 bars	2000 tr/min	3500 tr/min	30X30mm	- €
POMPE GR1/1,6CC DROITE EUROPE D25	1,6	200 bars	250 bars	2000 tr/min	3500 tr/min	30X30mm	- €
POMPE GR1/1,8CC DROITE EUROPE D25	1,8	200 bars	250 bars	2000 tr/min	3500 tr/min	40X30mm	- €
POMPE GR1/2,7CC DROITE EUROPE D25	2,7	200 bars	250 bars	2000 tr/min	3500 tr/min	40X30mm	- €
POMPE GR1/3,2CC DROITE EUROPE D25	3,2	200 bars	250 bars	2000 tr/min	3500 tr/min	40X30mm	- €
POMPE GR1/3,7CC DROITE EUROPE D25	3,7	200 bars	250 bars	2000 tr/min	3500 tr/min	40X30mm	- €
POMPE GR1/4,8CC DROITE EUROPE D25	4,8	200 bars	250 bars	2000 tr/min	3500 tr/min	40X30mm	- €
POMPE GR1/5,8CC DROITE EUROPE D25	5,8	200 bars	250 bars	2000 tr/min	3500 tr/min	40X30mm	- €
POMPE GR1/6,3CC DROITE EUROPE D25	6,3	160 bars	200 bars	2000 tr/min	3500 tr/min	40X30mm	- €
POMPE GR1/8,0CC DROITE EUROPE D25	8	160 bars	200 bars	2000 tr/min	3500 tr/min	40X30mm	- €

en standard rotation droite - sens de rotation gauche tarif identique

**POMPE A ENGRENAGE - GROUPE 2 - STANDARD EUROPE - COLERETTE DIAMETRE 36 mm**

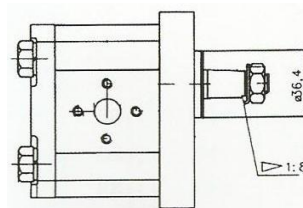
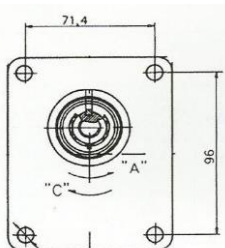
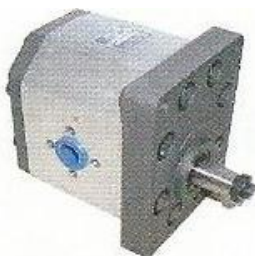

**ARBRE CONIQUE 1:8 - BRIDE EUROPE**

	CYLIND. CC	PRESSION SERVICE	PRESSION MAX	ROTATION SERVICE	ROTATION MAX	BRIDES EUROPE	TARIF
POMPE GR2/4CC DROITE EUROPE D36	4	200 bars	250 bars	2000 tr/min	3500 tr/min	30X30mm	- €
POMPE GR2/6CC DROITE EUROPE D36	6	200 bars	250 bars	2000 tr/min	3500 tr/min	30X30mm	- €
POMPE GR2/8CC DROITE EUROPE D36	8	200 bars	250 bars	2000 tr/min	3500 tr/min	30X30mm	- €
POMPE GR2/12CC DROITE EUROPE D36	12	200 bars	250 bars	2000 tr/min	3500 tr/min	40X30mm	- €
POMPE GR2/14CC DROITE EUROPE D36	14	200 bars	250 bars	2000 tr/min	3500 tr/min	40X30mm	- €
POMPE GR2/16CC DROITE EUROPE D36	16	200 bars	250 bars	2000 tr/min	3500 tr/min	40X30mm	- €
POMPE GR2/20CC DROITE EUROPE D36	20	200 bars	250 bars	2000 tr/min	3500 tr/min	40X30mm	- €
POMPE GR2/23CC DROITE EUROPE D36	23	200 bars	250 bars	2000 tr/min	3500 tr/min	40X30mm	- €
POMPE GR2/25CC DROITE EUROPE D36	25	200 bars	250 bars	2000 tr/min	3500 tr/min	40X30mm	- €
POMPE GR2/28CC DROITE EUROPE D36	28	160 bars	200 bars	2000 tr/min	3500 tr/min	40X30mm	- €
POMPE GR2/30CC DROITE EUROPE D36	30	160 bars	200 bars	2000 tr/min	3500 tr/min	40X30mm	- €

en standard rotation droite - sens de rotation gauche tarif identique

**POMPE A ENGRENAGE - GROUPE 2 - STANDARD ALLEMAND - COLERETTE DIAMETRE 50 mm**

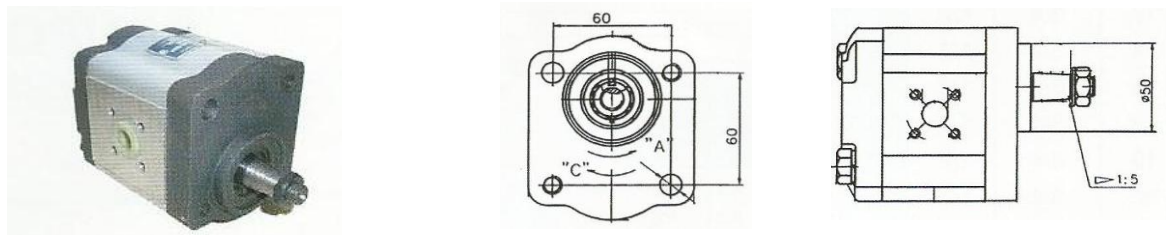

ARBRE CONIQUE 1:5 - BRIDE BOCH

	CYLIND. CC	PRESSION SERVICE	PRESSION MAX	ROTATION SERVICE	ROTATION MAX	BRIDES EUROPE	TARIF
POMPE GR2/6CC DROITE ALLEMAND D50	6	200 bars	250 bars	2000 tr/min	3500 tr/min	40X35mm	SD
POMPE GR2/8CC DROITE ALLEMAND D50	8	200 bars	250 bars	2000 tr/min	3500 tr/min	40X35mm	SD
POMPE GR2/12CC DROITE ALLEMAND D50	12	200 bars	250 bars	2000 tr/min	3500 tr/min	40X35mm	SD
POMPE GR2/14CC DROITE ALLEMAND D50	14	200 bars	250 bars	2000 tr/min	3500 tr/min	40X35mm	SD
POMPE GR2/16CC DROITE ALLEMAND D50	16	200 bars	250 bars	2000 tr/min	3500 tr/min	40X35mm	SD
POMPE GR2/20CC DROITE ALLEMAND D50	20	200 bars	250 bars	2000 tr/min	3500 tr/min	40X35mm	SD
POMPE GR2/23CC DROITE ALLEMAND D50	23	200 bars	250 bars	2000 tr/min	3500 tr/min	40X35mm	SD
POMPE GR2/25CC DROITE ALLEMAND D50	25	200 bars	250 bars	2000 tr/min	3500 tr/min	40X35mm	SD

en standard rotation droite - sens de rotation gauche tarif identique

**POMPE A ENGRENAGE - GROUPE 2 - STANDARD ALLEMAND - COLERETTE DIAMETRE 80 mm**

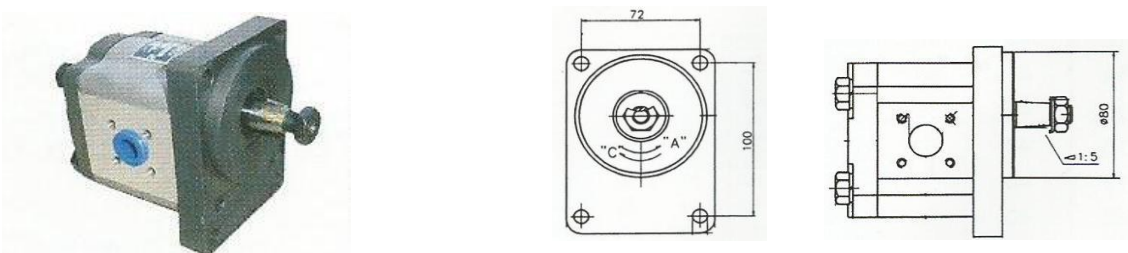

ARBRE CONIQUE 1:5 - BRIDE BOCH

	CYLIND. CC	PRESSION SERVICE	PRESSION MAX	ROTATION SERVICE	ROTATION MAX	BRIDES EUROPE	TARIF
POMPE GR2/6CC DROITE ALLEMAND D80	6	200 bars	250 bars	2000 tr/min	3500 tr/min	40X35mm	- €
POMPE GR2/8CC DROITE ALLEMAND D80	8	200 bars	250 bars	2000 tr/min	3500 tr/min	40X35mm	- €
POMPE GR2/12CC DROITE ALLEMAND D80	12	200 bars	250 bars	2000 tr/min	3500 tr/min	40X35mm	- €
POMPE GR2/14CC DROITE ALLEMAND D80	14	200 bars	250 bars	2000 tr/min	3500 tr/min	40X35mm	- €
POMPE GR2/16CC DROITE ALLEMAND D80	16	200 bars	250 bars	2000 tr/min	3500 tr/min	40X35mm	- €
POMPE GR2/20CC DROITE ALLEMAND D80	20	200 bars	250 bars	2000 tr/min	3500 tr/min	40X35mm	- €
POMPE GR2/23CC DROITE ALLEMAND D80	23	200 bars	250 bars	2000 tr/min	3500 tr/min	40X35mm	- €
POMPE GR2/25CC DROITE ALLEMAND D80	25	200 bars	250 bars	2000 tr/min	3500 tr/min	40X35mm	- €

en standard rotation droite - sens de rotation gauche tarif identique

**POMPE A ENGRENAGE - GROUPE 3 - STANDARD EUROPE - COLERETTE DIAMETRE 50 mm**

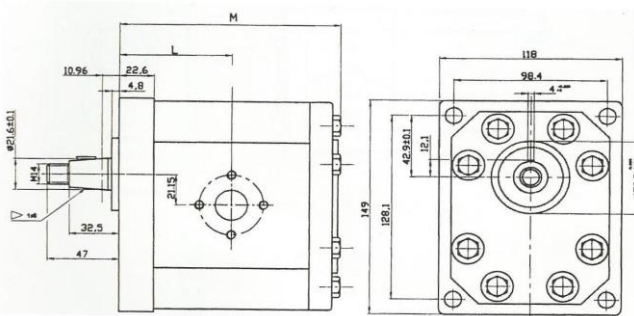

**ARBRE CONIQUE 1:8 - BRIDE EUROPE**

	CYLIND. CC	PRESSION SERVICE	PRESSION MAX	ROTATION SERVICE	ROTATION MAX	BRIDES EUROPE	TARIF
POMPE GR3/22CC DROITE EUROPE D50	22	200 bars	250 bars	2000 tr/min	3500 tr/min	40X40mm	- €
POMPE GR3/26CC DROITE EUROPE D50	26	200 bars	250 bars	2000 tr/min	3500 tr/min	40X40mm	- €
POMPE GR3/28CC DROITE EUROPE D50	28	200 bars	250 bars	2000 tr/min	3500 tr/min	40X40mm	- €
POMPE GR3/34CC DROITE EUROPE D50	34	200 bars	250 bars	2000 tr/min	3500 tr/min	40X40mm	- €
POMPE GR3/39CC DROITE EUROPE D50	39	200 bars	250 bars	2000 tr/min	3500 tr/min	40X40mm	- €
POMPE GR3/43CC DROITE EUROPE D50	43	200 bars	250 bars	2000 tr/min	3500 tr/min	50X40mm	- €
POMPE GR3/46CC DROITE EUROPE D50	46	200 bars	250 bars	2000 tr/min	3500 tr/min	50X40mm	- €
POMPE GR3/51CC DROITE EUROPE D50	51	200 bars	250 bars	2000 tr/min	3500 tr/min	50X40mm	- €
POMPE GR3/55CC DROITE EUROPE D50	55	200 bars	250 bars	2000 tr/min	3500 tr/min	50X40mm	- €

en standard rotation droite - sens de rotation gauche tarif identique

**BRIDE DE POMPE 90°  
STANDART EUROPEEN**

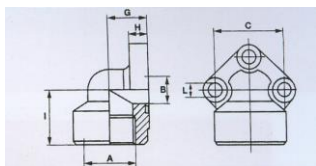

REFERENCE	TARIF
BRIDE 90° POMPE EUROPE 26F3/8	- €
BRIDE 90° POMPE EUROPE 26F1/2	- €
BRIDE 90° POMPE EUROPE 30F3/8	- €
BRIDE 90° POMPE EUROPE 30F1/2	- €
BRIDE 90° POMPE EUROPE 40F1/2	- €
BRIDE 90° POMPE EUROPE 40F3/4	- €
BRIDE 90° POMPE EUROPE 51F3/4	- €
BRIDE 90° POMPE EUROPE 51F1"	- €
BRIDE 90° POMPE EUROPE 56F3/4"	- €
BRIDE 90° POMPE EUROPE 56F1"	- €

**BRIDE DE POMPE 90°  
STANDART BOSCH**

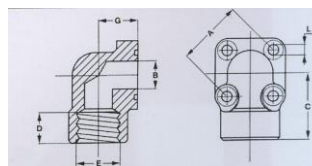

REFERENCE	TARIF
BRIDE 90° POMPE BOSCH 35F3/8	- €
BRIDE 90° POMPE BOSCH 35F1/2	- €
BRIDE 90° POMPE BOSCH 40F1/2	- €
BRIDE 90° POMPE BOSCH 40F3/4	- €
BRIDE 90° POMPE BOSCH 55F3/4	- €
BRIDE 90° POMPE BOSCH 55F1"	- €

**POUR LES TARIFS DES BRIDES DE POMPE  
CHAPITRE 3 - ADAPTEURS A BRIDES**

**BRIDE DE POMPE DROITE  
STANDART EUROPEEN**

REFERENCE	TARIF
BRIDE POMPE EUROPE 30F3/8	- €
BRIDE POMPE EUROPE 40F1/2	- €
BRIDE POMPE EUROPE 51F3/4	- €
BRIDE POMPE EUROPE 56F3/4	- €



**MOTEUR ORBITAUX TYPE MOMR**

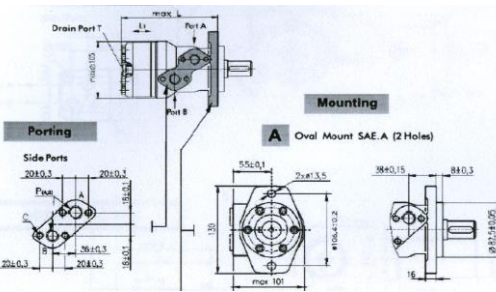
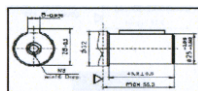

DMAR 50 - L140 - L,10
DMAR 80 - L146 - L,16
DMAR 100 - L150 - L,20
DMAR 125 - L155 - L,25
DMAR 160-L161,5 - L,31,5
DMAR 200 - L170 - L,40
DMAR 250 - L180 - L,50
DMAR 315 - L192 - L,62
DMAR 400 - L204 - L,74

	MOMR 50	MOMR 80	MOMR 100	MOMR 125	MOMR 160	MOMR 200	MOMR 250	MOMR 315	MOMR 400
CYLINDREE	51,2 cc	80,5 cc	100,8 cc	125,1 cc	159,4 cc	199,6 cc	249,8 cc	315,7 cc	396,5 cc
PRESSION CONTINU	140 bars	160 bars	160 bars	160 bars	160 bars	135 bars	105 bars	85 bars	65 bars
PRESSION MAX	175 bars	180 bars	180 bars	180 bars	180 bars	175 bars	160 bars	130 bars	75 bars
DEBIT CONTINU	40 l/min	60 l/min	60 l/min	60 l/min	60 l/min	60 l/min	60 l/min	60 l/min	60 l/min
DEBIT MAX	50 l/min	75 l/min	75 l/min	75 l/min	75 l/min	75 l/min	75 l/min	75 l/min	75 l/min
ROTATION CONTINU	770 tr/min	745 tr/min	600 tr/min	470 tr/min	370 tr/min	300 tr/min	240 tr/min	190 tr/min	150 tr/min
ROTATION MAX	970 tr/min	940 tr/min	750 tr/min	600 tr/min	470 tr/min	370 tr/min	300 tr/min	240 tr/min	190 tr/min
FILETAGE	FEM 1/2	FEM 1/2	FEM 1/2	FEM 1/2	FEM 1/2	FEM 1/2	FEM 1/2	FEM 1/2	FEM 1/2
POIDS	6,7 kg	6,9 kg	6,9 kg	7,2 kg	7,5 kg	8,1 kg	8,5 kg	9,1 kg	9,5 kg
TARIF	- €	- €	- €	- €	- €	- €	- €	- €	- €



**MOTEUR ORBITAUX TYPE MOMP**

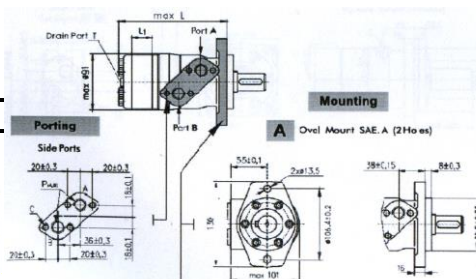
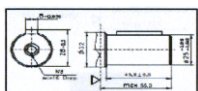

DMAP 50 - L137 - L,7
DMAP 80-L140,5 - L,10,5
DMAP 100 - L143 - L,13
DMAP 125 - L146 - L,16
DMAP 160 - L151 - L,21
DMAP 200 - L157 - L,26
DMAP 250 - L162 - L,32
DMAP 315 - L172 - L,42
DMAP 400 - L182 - L,52

	MOMP 50	MOMP 80	MOMP 100	MOMP 125	MOMP 160	MOMP 200	MOMP 250	MOMP 315	MOMP 400
CYLINDREE	50,8 cc	78,8 cc	98,6 cc	123,5 cc	158,6 cc	197,9 cc	247,5 cc	316,5 c	396,5 cc
PRESSION CONTINU	140 bars	140 bars	140 bars	140 bars	140 bars	135 bars	105 bars	80 bars	65 bars
PRESSION MAX	175 bars	175 bars	175 bars	175 bars	175 bars	160 bars	140 bars	115 bars	90 bars
DEBIT CONTINU	50 l/min	60 l/min	60 l/min	60 l/min	60 l/min	60 l/min	60 l/min	60 l/min	60 l/min
DEBIT MAX	60 l/min	75 l/min	75 l/min	75 l/min	75 l/min	75 l/min	75 l/min	75 l/min	75 l/min
ROTATION CONTINU	1180 tr/min	760 tr/min	600 tr/min	485 tr/min	380 tr/min	300 tr/min	240 tr/min	190 tr/min	150 tr/min
ROTATION MAX	1380 tr/min	940 tr/min	750 tr/min	600 tr/min	475 tr/min	380 tr/min	300 tr/min	235 tr/min	190 tr/min
FILETAGE	FEM 1/2	FEM 1/2	FEM 1/2	FEM 1/2	FEM 1/2	FEM 1/2	FEM 1/2	FEM 1/2	FEM 1/2
POIDS	5,6 kg	5,7 kg	5,9 kg	6,0 kg	6,2 kg	6,4 kg	6,6 kg	6,9 kg	7,4 kg
TARIF	- €	- €	- €	- €	- €	- €	- €	- €	- €





**MOTEUR ORBITAUX TYPE MOMS**

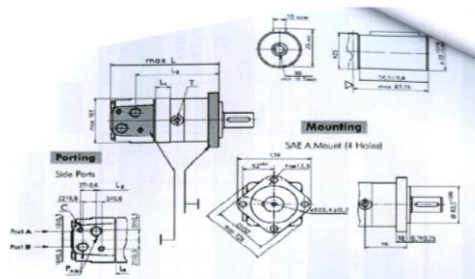

DMAS 80 - L167 - L1,13
DMAS 100 - L171 - L1,17
DMAS 125 - L176 - L1,22
DMAS 160 - L181,5 - L1,27,5
DMAS 200 - L189 - L1,35,1
DMAS 250 - L201 - L1,47
DMAS 315 - L213 - L1,59
DMAS 400 - L225 - L1,71

	MOMS 80	MOMS 100	MOMS 125	MOMS 160	MOMS 200	MOMS 250	MOMS 315	MOMS 400
CYLINDREE	80,8 cc	99,8 cc	125,2 cc	159,2 cc	200 cc	252,3 cc	315,1 c	397 cc
PRESSION CONTINU	175bars	175 bars	175 bars	160 bars	150 bars	140 bars	120 bars	100 bars
PRESSION MAX	210 bars	210 bars	210 bars	210 bars	180 bars	175 bars	140 bars	120 bars
DEBIT CONTINU	65 l/min	75 l/min	75 l/min	75 l/min	75 l/min	75 l/min	75 l/min	75 l/min
DEBIT MAX	80 l/min	90 l/min	90 l/min	90 l/min	90 l/min	90 l/min	90 l/min	90 l/min
ROTATION CONTINU	805 tr/min	746 tr/min	598 tr/min	465 tr/min	373 tr/min	298 tr/min	236 tr/min	187 tr/min
ROTATION MAX	1000 tr/min	900 tr/min	718 tr/min	560 tr/min	447 tr/min	360 tr/min	290 tr/min	230 tr/min
FILETAGE	FEM 1/2	FEM 1/2	FEM 1/2	FEM 1/2	FEM 1/2	FEM 1/2	FEM 1/2	FEM 1/2
POIDS	10,0 kg	10,3 kg	10,5 kg	11,0 kg	11,4 kg	11,9 kg	12,5 kg	13,5 kg
TARIF	- €	- €	- €	- €	- €	- €	- €	- €



**MOTEUR ORBITAUX TYPE MOMT**

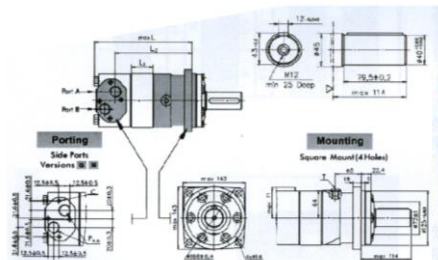

TYPE	L	L2	-L1
MAT 160	183	143	17
MAT 200	197	147	21
MAT 250	203	153	27
MAT 315	206	157	23
MAT 400	215	164	27
MAT 500	223	172	35
MAT 630	235	184	47
MAT 800	248	195	53

	MOMT 160	MOMT 200	MOMT 250	MOMT 315	MOMT 400	MOMT 500	MOMT 630	MOMT 800
CYLINDREE	161,2 cc	201,5 cc	250,4 cc	319,5 cc	401,8 cc	523,5 cc	629 cc	801 cc
PRESSION CONTINU	200 bars	200 bars	200 bars	200 bars	180 bars	160 bars	140 bars	125 bars
PRESSION MAX	240 bars	240 bars	240 bars	240 bars	210 bars	180 bars	160 bars	130 bars
DEBIT CONTINU	100 l/min	125 l/min	125 l/min	125 l/min	125 l/min	125 l/min	125 l/min	125 l/min
DEBIT MAX	125 l/min	150 l/min	150 l/min	150 l/min	150 l/min	150 l/min	150 l/min	150 l/min
ROTATION CONTINU	615 tr/min	615 tr/min	495 tr/min	375 tr/min	300 tr/min	235 tr/min	196 tr/min	154 tr/min
ROTATION MAX	770 tr/min	750 tr/min	600 tr/min	455 tr/min	360 tr/min	285 tr/min	233 tr/min	185 tr/min
FILETAGE	FEM 3/4	FEM 3/4	FEM 3/4	FEM 3/4	FEM 3/4	FEM 3/4	FEM 3/4	FEM 3/4
POIDS	20,0 kg	21,0 kg	21,0 kg	21,5 kg	22,0 kg	23,0 kg	24,0 kg	25,0 kg
TARIF	- €	- €	- €	- €	- €	- €	- €	- €